

The
WIRELESS
WORLD



**"ANTI-SULPHURIC" ENAMEL
RESISTS ACID FUMES, Etc.**

**GRIFFITHS BROS. & Co. (London) Lt
MACKS ROAD, BERMONDSEY, S.E.**

SULLIVAN INSTRUMENTS

Sullivan "Universal" Galvanometers and Shunts for Land and Sea use

SULLIVAN TELEPHONE RECEIVERS

Fast Speed Wheatstone Automatic Transmitters and Receivers guaranteed at 400 words per minute, and Wheatstone Apparatus generally. Precision and Standard Measuring Equipments for D.C. and A.C. (high frequency) determinations, Condensers of Low Power Factor, etc

H. W. SULLIVAN, WINCHESTER HOUSE, LONDON, E.C., ENGLAND

Telegrams—
"Deadbeat, London."

Telephone: Office: 3518 London Wall.
Works: 4871 Avenue.

WORKS: LIVERPOOL HOUSE, MIDDLESEX STREET
LONDON, E.C.

P. ORMISTON & SONS

(P. H. ORMISTON) :: ESTABLISHED 1793

79 Clerkenwell Rd., London, E.C. 1

"Ormiston, London." :: :: 13259 Central

Silk and Cotton Covered H.C. Copper Wire, Resistance Wires, Fuse Wire, Binding Wires, Charcoal Iron Core Wire, Asbestos Covered Wire, Braided and Twisted Wires, Bare Copper Strand and Flexibles of any Construction, Wire Ropes and Cords (fine sizes) in Galvanized Steel, Phosphor Bronze, &c.

COMMERCIAL UNION

ASSURANCE CO., LTD.

Head Office:

24, 25 & 26, CORNHILL, LONDON, E.C.

The following classes of Insurance effected: FIRE, LIFE AND ANNUITIES, MARINE, LEASEHOLD REDEMPTION AND SINKING FUND, ACCIDENT, including Personal Accident, Third Party, Burglary, Plate Glass, Fidelity Guarantee, Employers' Liability and Workmen's Compensation, including Domestic Servants' Insurance. The Company also act as TRUSTEES AND EXECUTORS.

FIRE, LIFE, MARINE, ACCIDENT.

Capital fully Subscribed	£2,950,000
Capital Paid Up	£295,000
Total Assets (including Life Funds)	£24,902,252
31st December, 1913	£8,500,000
Total Annual Income exceeds	£8,500,000



THE BRITISH SCHOOL of TELEGRAPHY Ltd.

179, CLAPHAM RD.
LONDON, S.W.

EXPERT TRAINING FOR YOUNG GENTLEMEN (15-25) IN INLAND, CABLE & WIRELESS TELEGRAPHY. Good Appointments are open to our students as soon as qualified, the demand for Skilled Operators in all Services being greater than the supply. Special Short Course suitable for men wishing to obtain Government Certificate and enter the service of the Marconi Co. At several recent Government Exams. all candidates obtained 1st Class Government Certificate. No Branches or Postal Tuition. Fees moderate. Recognised by the War Office, Admiralty, Wireless Telegraph and Cable Companies.

WRITE FOR PROSPECTUS. A. W. WARD (Manager). 'Phone: BRIXTON 215

THE WIRELESS WORLD

No. 79
Vol. VII



OCTOBER,
1919

Wireless Telegraphy at Archangel

An Account of the Station and Conditions Encountered.

By R. K. RICE, A.M.I.E.E.

IN the latter part of 1918 the construction of a medium power station for communication between General Ironside's Forces at Archangel and the British Isles and Admiral Koltchak's troops in Siberia was commenced to the order of the War Office.

Cable communication had been interrupted in November and as the fault had been located in or around a mine-field there was some urgency in establishing direct wireless communication. The distance between Aberdeen and Archangel is approximately 1,300 miles and for this purpose a 25-k.w. Marconi Arc Set employing two 305-ft. sectional steel masts (Gray pattern) 600 ft. apart, was designed and supplied. The completed set comprises a 50-h.p. Diesel Oil Engine belt coupled to a 30-k.w. Crompton d.c. generator delivering 350/600 volts. The arc may be run directly off the generator or off a 600-ampere-hour Chloride battery of 200 units. A motor-generator set capable of supplying 110 volts is used to feed the auxiliary circuits and for lighting pur-

poses. Our photograph shows the engine, dynamo, motor-generator set and the main switchboard controlling battery charge, aerial heating and auxiliary circuits. To the right may be seen a Lister 3-k.w. self-contained lighting set used for charging small accumulators for receivers and for various other purposes.

The gear is housed in a wooden building some 150 feet long by 38 feet wide, having an inner and outer lining separated 6 inches apart. The roof is covered with felt and all windows are double. Three large wood-burning stoves of Russian pattern are used for heating the whole building. The building comprises accumulator, engine, transmitting and receiving rooms and an office for the Engineer-in-Charge. All floors are of wood with the exception of the engine room which is concreted. The tanks for the water cooling of the engine are housed inside the building.

Owing to the presumed absence of sand and stone for concreting some 300 tons were shipped from England and great precaution had to be taken whilst laying the engine room floor in heating

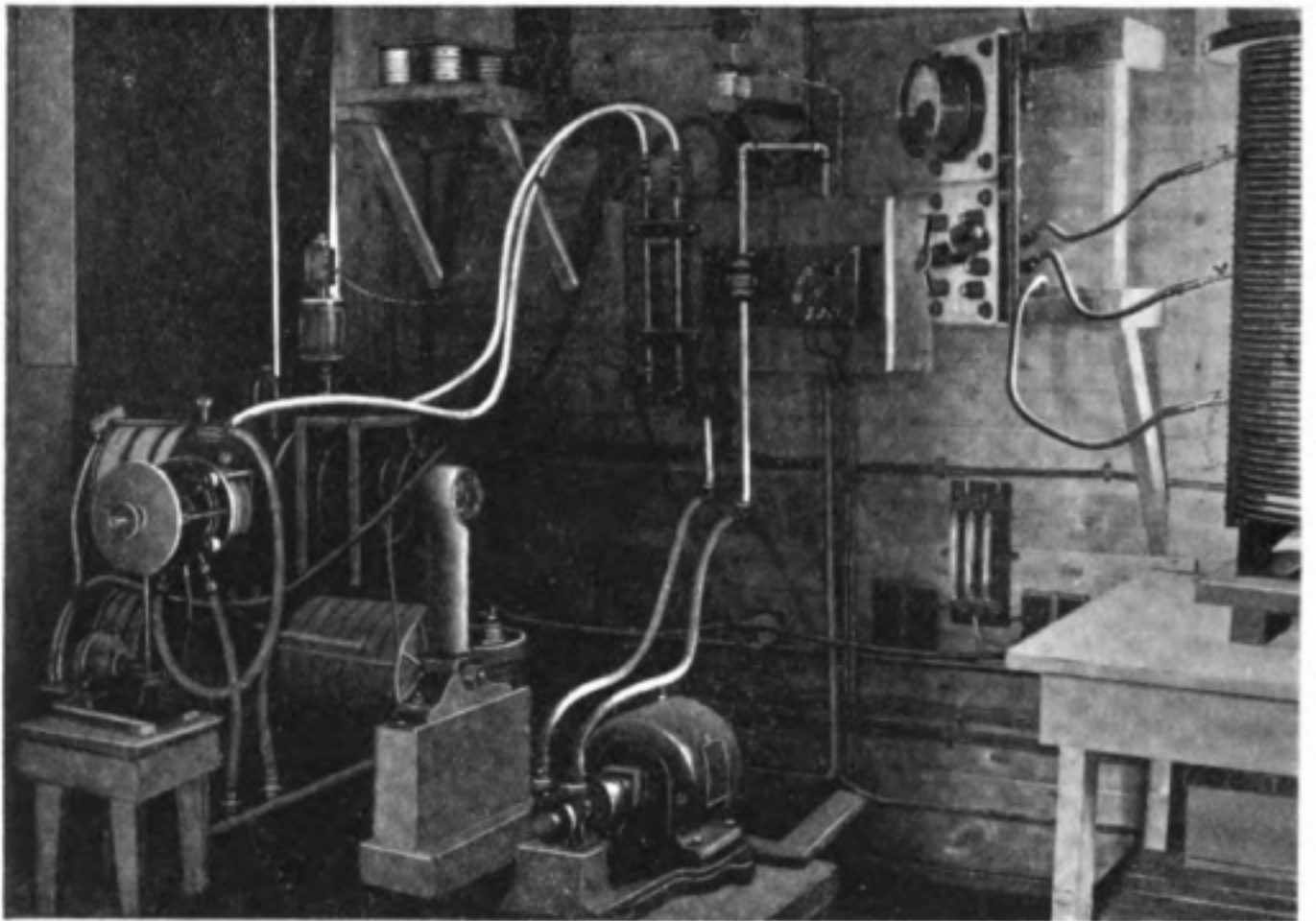

25-k.w. Marconi Arc Set.



Relief of Archangel by British Forces: Presentation of Bread and Salt by Local Russian Government.

WIRELESS TELEGRAPHY AT ARCHANGEL.

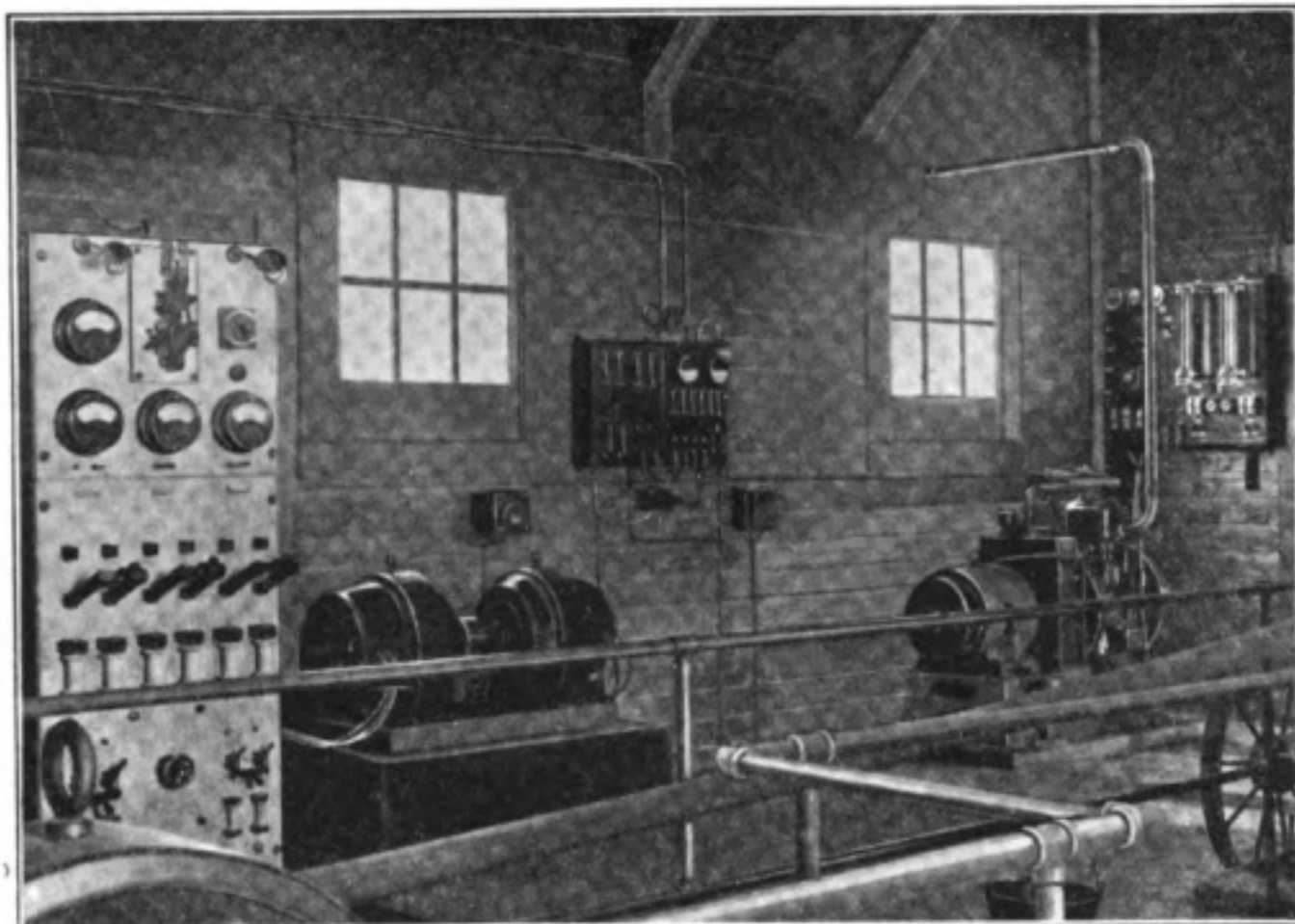

Engine Room, showing Main Switchboard and Motor Generator.

all the aggregate and employing hot water for the mixing.

It was hoped that if conditions permitted the outside work of concreting mast anchorages and foundations might be pushed ahead before the winter set in. Unfortunately owing to local transport difficulties this work was unable to be undertaken before the thaw set in some six months later, and thus it was imperative that if the working of the station was to be expedited the employment of wooden masts should be substituted for the steel ones as a temporary measure. Two 200-foot masts were therefore designed, and during the time these were under construction and erection, the building and installing of the engine and gear were being proceeded with, and by the end of February a four-wire triangular aerial, a conduction earth and the remainder of the installation had been completed, and

communication had been established with the British Isles. Work on the steel masts was commenced in the latter part of April and concluded in May, when a more substantial 6-wire triangular aerial was erected.

The receivers comprise two separate sets—one for long, the other for short-wave reception, and consist of simple plain aerial and tuned circuits coupled to Type 55A amplifiers used in conjunction with a Mark 4 three-valve note amplifier.

One of the many difficulties to be encountered during the winter when a temperature of minus 30 degrees was experienced, was the transportation of the engine flywheel, weighing 5 tons, in one piece over a distance of three miles. This was accomplished partly by rail across the river Dvina, when a specially constructed sleigh hauled by two caterpillar tractors was used to haul it to the

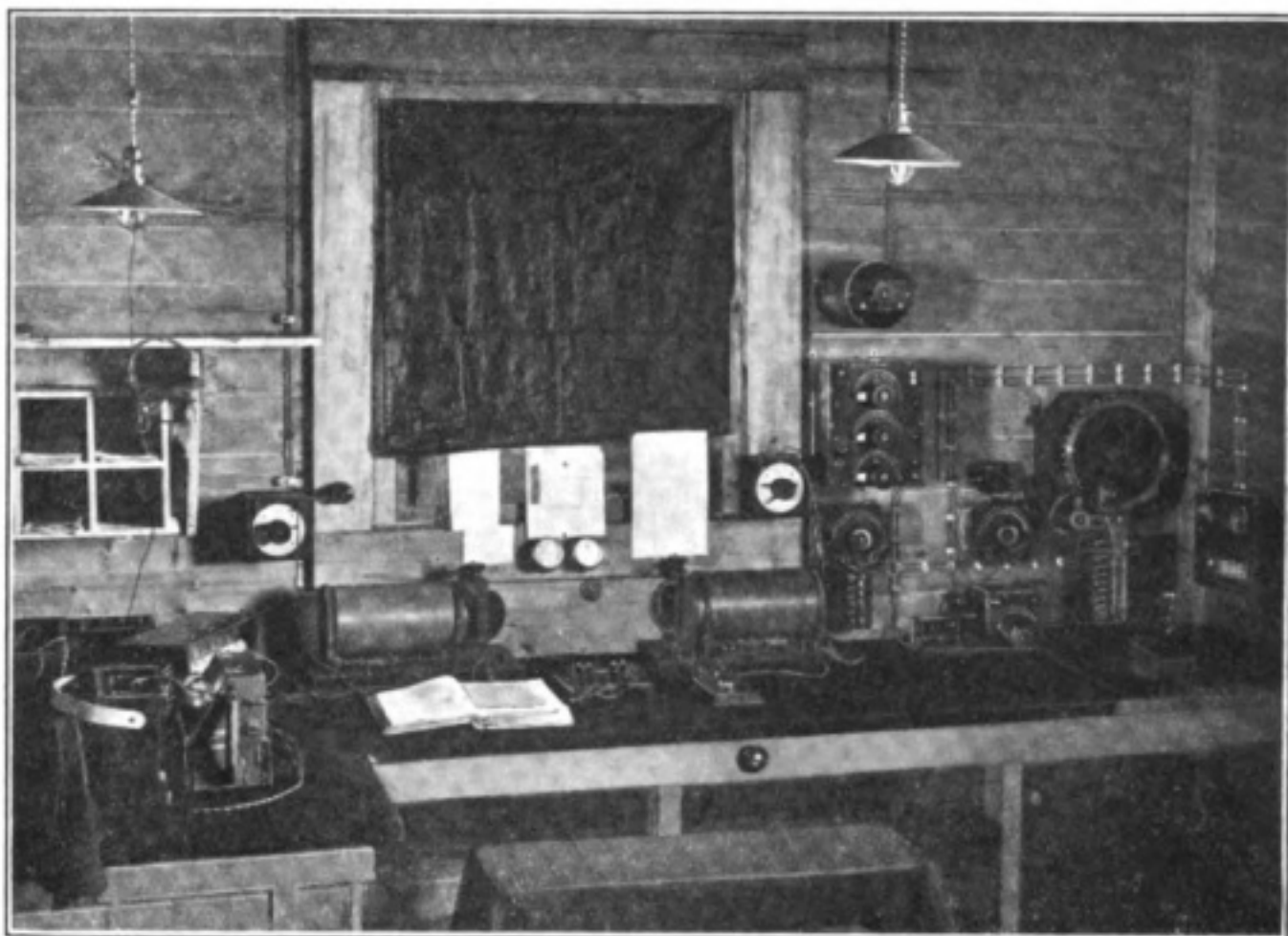

Receiving Room at Archangel Station.



A Scene on the frozen Dvina.

WIRELESS TELEGRAPHY AT ARCHANGEL.



Erection of 200ft. Wood Mast.

site, not without considerable difficulty. Other difficulties encountered were the laying of a suitable symmetrical earth ring in soil which resembled iron in hardness, and the difficulty in keeping all water pipes for engine and arc free from frost, even the smallest crack in the woodwork being sufficient to cause a block with the resultant bursting of the pipe. Even the handling of spanners was sometimes an unpleasant experience, as if left in the open for a short time they were apt to burn one's hands, and sometimes when resort was had to warming them over the stoves one was uncertain if they were genuinely hot or still cold! It was anticipated that silver thaw on the aerial might prove to cause considerable inconvenience and arrangements were therefore made for the aerial to be so designed that a current of over 200 amperes might be passed through it when required.

Atmospherics were also a varying quantity. During the winter they appear to be normal, but when continuous daylight exists in the spring and

summer months the conditions reverse themselves, that is to say, the free period is during the night, and atmospherics are severe from 10 a.m. till 4 p.m., when they attain their maximum, falling off gradually till 10 p.m.

Observations were also made of the effect of the Aurora Borealis, and it was recorded that if the display was at all pronounced a continuous roar is heard in the telephones.

Marked improvement results in signalling conditions during the reversal of the seasons. Aerial currents increase practically 50 per cent. when the soil becomes thoroughly conductive and the resistance of the aerial falls proportionately.

On the whole it may be said that the erection of wireless stations in the extreme cold is hardly a humorous pastime—perhaps the Russian engine room attendant thinks differently, however, when he finds another and more agreeable way of disposing of the methylated spirit which the arc chamber always seems to sigh for.



MR. HERMOD PETERSEN

Personalities in the Wireless World

MR. HERMOD PETERSEN was born in Christiania in 1875. After entering the Telegraph Service in 1893 he was for some years a telegraph clerk, being at the same time employed in constructing telegraph lines in the North of Norway. Later on he graduated as electrical engineer at Bergen Technical College, and completed his education at the Technical High School of Karlsruhe, Germany. On his return in 1900 he was appointed Chief of the Telegraph Schools, which position he held for 13 years, doing a most valuable work in the developing of systematic theoretical and practical telegraph training. Mr. Petersen contrived to make his pupils feel interested in their work, and most of the younger men in the ordinary as well as in the Wireless Telegraph Service have reason to be thankful to him for their sound training. He remedied the existing want of instructional books by writing quite a number of excellent works on Telegraphy, Telephony and Wireless Telegraphy.

Owing to the large extent and great shipping of the country, Wireless Telegraphy is bound to be of the utmost importance to Norway, and the number of land and ship stations is already considerable and increasing fast. In this development Mr. Hermod Petersen has taken an important part, and is recognised as one of the most prominent pioneers in this domain, commencing as early as 1901, when he superintended the first wireless experiments in the country. He trained the first military and the whole Government Telegraph staff of wireless men, besides delivering numerous lectures with a view to rousing public interest in this new means of communication. As Chief of the Wireless Department, with which position he was entrusted in 1913, he laid down the technical plans and supervised the construction of most of the Wireless land stations in the country. The erection of the Wireless Station at Spitsbergen, which was attended by considerable difficulties, Mr. Petersen undertook as Engineer-in-Charge, and in order to ensure its good working he remained in charge during its first winter of Arctic night. As representative of the telegraph department he has had the control of the erection of the large station near Stavanger, which is to communicate with America, and as Government Wireless Inspector he controls all the ship stations of the country. Since July, 1919, he has held the post of Chief Wireless Engineer of the Norwegian Government Wireless Stations.

Mr. Hermod Petersen's recognised ability in the field of theoretical research, combined with sound, practical knowledge and a vivid interest in wireless work in general, renders him eminently suitable for the important position he holds. In connection with his work he has travelled in England, France and Germany, and he was a member of the first International Conference on Wireless Telegraphy held in Berlin in 1906.

Simplified Inductance Calculations

WITH SPECIAL REFERENCE TO THICK COILS.

By PHILIP R. COURSEY, B.Sc., A.M.I.E.E.

Abstract of Paper read before the Physical Society of London (*Proceedings of the Physical Society*, 31, pp. 155-167, Aug., 1919.)

1. The predetermination of the inductance of coils by direct arithmetical calculation is a subject to which a great deal of attention has been devoted. The results are seen in the many published Papers giving formulæ for this purpose. Most of these formulæ have been obtained by rigid mathematical deduction, but some are empirical. Many are very complicated, and unsuited for easy computation.

Several writers have attempted the simplification of some of these formulæ to render them more suitable for everyday use. Often this has resulted in a limitation of their range of applicability to certain selected cases, and in some instances confusion has arisen through imperfect statement of the limits between which the particular formula may be employed.

2. Notation.

Let—

L = Inductance of coil in centimetres.

D = Mean diameter of coil (cm.) = $2a$.

a = Mean radius of coil.

l = Axial length (cm.).

d = Radial depth of windings (cm.).

N = Total number of actual turns of wire.

$n = N/l$ = Number of turns of wire per centimetre of length.

k = Correction factor for single layer windings.

δk = Correction for coil thickness.

k' = Correction factor for thick coils.

$m, A, B, \&c.$ = Other factors used in various formulæ.

3. Single Layer Coils.

The calculation of the inductance of single-layer coils has, perhaps, received most attention in the direction of simplification on account of the practical requirements in the realm of wireless and other high-frequency apparatus. Several abacs, charts and curves have been published with this end in view.

When dealing with single layer coils one of the most useful, and, at the same time, most accurate and universal of the available formulæ is that of Nagaoka.* The main part of this formula, viz. :—

$$L = \pi^2 D^2 n^2 l k \quad \dots \quad (1)$$

* Nagaoka, "Journal" College of Science, Tokyo, XXVII., p. 18 (1909); also "Bulletin" of Bureau of Standards, Washington, VIII., p. 119 (1912).

SIMPLIFIED INDUCTANCE CALCULATIONS.

is very easily dealt with, but the expressions for calculating the factor k for the various cases of long or short coils are very cumbersome and tedious to use. Extensive tables of this factor have, however, been published in the "Bulletin" of the Bureau of Standards, and elsewhere, giving the values of k in terms of the ratio $D/l = \text{diameter} \div \text{length of the coil}$.

The use of this formula in practice may be simplified by plotting curves of the values of k and reading the value required from these. This method has other special advantages when the design of a coil to have any predetermined value of inductance is under consideration, as has been previously pointed out by the author.*

The results given by this formula are, strictly speaking, liable to a correction for the insulation or spacing of the turns of wire, but in practice this correction is a small one (usually less than 1 per cent.), and may be neglected—at least to the approximation required for most practical work, for which curves are applicable.

This formula may be expressed in a number of different ways if so desired. Such modifications have given rise to a number of abacs and charts to simplify its use. In general, however, they amount to the same result as that given by the curves above, while their range is usually much more limited.

As an example we may mention Eccles's abac given in his "Handbook of Wireless Telegraphy." This is based on Russell's formula, and is written in the form

$$L = ma^3n^2 \quad \dots \quad (2)$$

Values of m are obtained from the abac in terms of the ratio l/D

If we equate this expression to the one used by Nagaoka, we have

$$m (D/2)^3 n^2 = \pi^2 D^2 n^2 l k,$$

or,

$$m = 8\pi^2 \frac{lk}{D} \quad \dots \quad (3)$$

We may therefore compare the results obtained by the two methods by working out values of $8\pi^2[lk/D]$.

Curves of lk/D were given by the author in the *Electrician*† for the purposes of the design of coils. Using these curves, we obtain the following table:—

l/D	lk/D from curve.	$8\pi^2 lk/D$.	m from abac.	Difference per cent
0.2	0.063	4.96	5.00	+0.8
0.65	0.384	30.3	30.2	-0.33
1.5	1.15	90.8	91.0	+0.22
2.4	2.04	161.0	160.0	-0.62
4.2	3.80	300.0	300.0	0.0
5.2	4.78	384.0	379.0	-1.3

The agreement is evidently very close. The useful range of the abac is, however, much more limited than that of the curves. It is only useful for comparatively short coils.

A very similar chart due to S. Lowey, published in the *WIRELESS WORLD*.‡

* P. R. Coursey, *Electrician*, LXXV., p. 841 (September, 1915).

† P. R. Coursey, *Electrician*, loc. cit.

‡ S. Lowey, *WIRELESS WORLD*, III., p. 664 (January, 1916).

amounts to practically the same abac arranged in a circular form, but with a slightly greater range, and expressed in terms of the coil diameter instead of its radius.

A disadvantage of transforming Nagaoka's formula in this manner, viz.: splitting it up into factors of D^3 , and lk/D , is that the factor m , which is proportional to lk/D , covers a much greater range of values—varying between 0 and ∞ —whereas the factor k is asymptotic to unity, and its value for all cases lies between 0 and 1. A curve or abac for k does not, therefore, require to be so extended.

4. *Thick Coils.*

When we come to consider the case of coils having a radial thickness that is not negligible compared with either the diameter or the length, these simplified formulæ become very inaccurate if used as they stand. Moreover the usual accurate expressions for these cases are not easy to work with in the forms generally given. These coils—"thick coils," as we may term them for distinctive purposes—have not perhaps quite such a wide sphere of use as the single layer coils, but, nevertheless, they are of importance in some branches of engineering, and are finding more extended use for high-frequency work than hitherto.

It is understood, of course, that these calculations always refer to "air-core" coils, or to be more general, to all coils having a core of permeability unity, as the inductance of iron-cored coils is too uncertain and variable a quantity to require predetermination in most cases.

The principle object of this Paper is to indicate how the simplified form of Nagaoka's formula, using the " k " curves, may be adapted to a general method of calculation applicable to all types of coils, whether thin or thick, short or long, of one turn or many.

In the single layer case considered above, the magnetic flux passing through the centre of the coil is linked with practically all the turns—the factor k correcting for the spreading of the flux at the ends of the coil. Evidently when more layers are added to the coil, the flux due to the inner layers does not link directly with the outer layers of wire, so that the effective inductance is less than it would be if the same number of turns were all concentrated upon a single outer layer. It should, therefore, be possible to allow for this reduction in inductance by introducing an appropriate reduction in the factor k . For this purpose a series of values of a factor δk have been calculated. This factor is to be subtracted from the proper value of k obtained from the curves, and the new value k' used with the standard formula (1) in the usual manner.

Hence we have

$$L = \pi^2 D^2 n^2 l (k - \delta k) = \pi^2 D^2 n^2 l k' \dots \dots \dots (4)$$

where $k' = (k - \delta k)$.

A series of values of this reduction factor δk have been worked out by using Rosa's formula* for the inductance of a thick coil. This easily gives us an expression in the form required, from which we get

$$\delta k = \frac{2}{\pi} \cdot \frac{d}{D} \cdot (A_1 + B_1) \dots \dots \dots (5)$$

* E. B. Rosa, "Bulletin" of Bureau of Standards, IV., p. 369 (1907); also VIII., p. 138 (1912).

SIMPLIFIED INDUCTANCE CALCULATIONS.

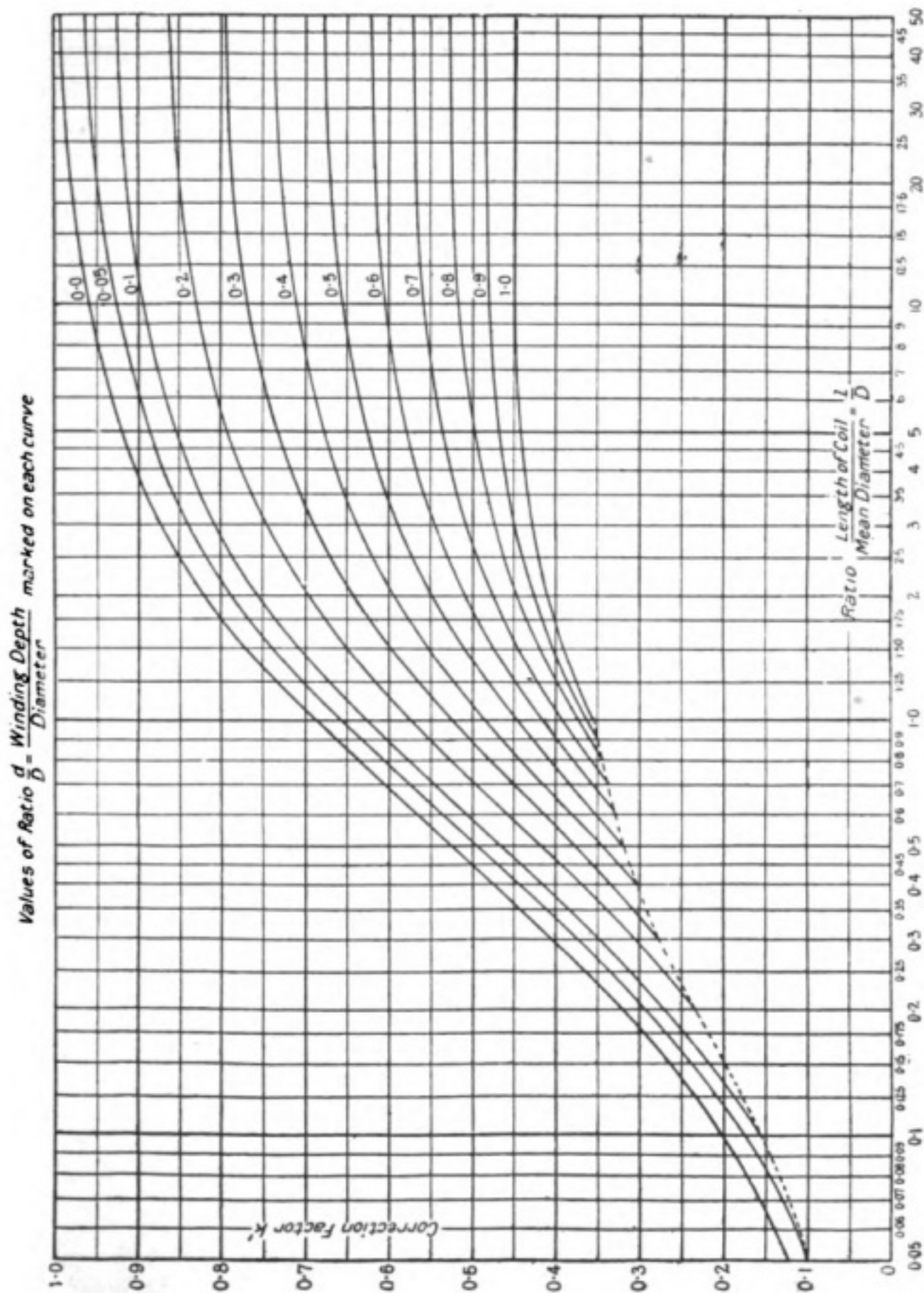

Fig. 1—Curves of Factor k' for all Coils (thick or thin).

The values of δk have been calculated from this expression by using the values for A , and B , tabulated by Rosa. A considerable number of extra values have also been calculated from the formulæ given in his original Paper*, as the tables were found insufficient for this purpose.

Evidently not only is it possible to plot curves of δk , as has been indicated, but a set of curves of the factor $k' = k - \delta k$ may also be plotted on one sheet to enable the appropriate factor for any coil to be read off at a glance. See Fig. 1.

These curves are plotted against the ratio l/D (= length \div diameter), so that the k curve for a single layer coil can also be included. A wide range of values is obtained by the use of the logarithmic scale. In using the curves it should be noted that when the winding depth d is greater than the axial length l , the values of l and d should be interchanged in working out the inductance both in the formula and in finding the factor k' . The inductances of the short thick coil and the long thin one of Fig. 2 are practically the same, provided that the mean diameters are identical.

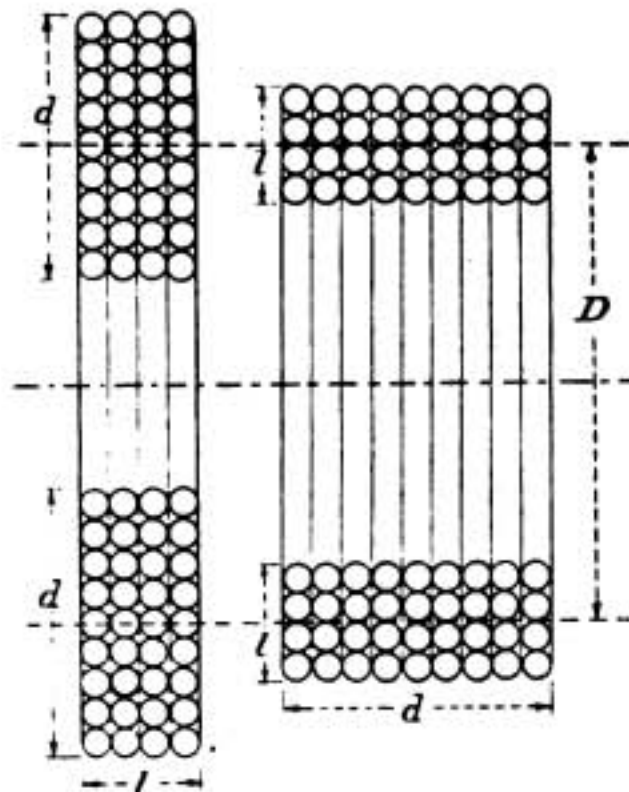

Fig. 2 Equal inductance Coils.

The results obtained from these curves have been compared with measurements on several coils, and have been found to be generally correct within a few per cent.

These k' curves have an advantage in being asymptotic as compared with others, in which the formula has been broken up into factors of n^2 , D^3 , and m , as for the single layer case (Eccles's Abac, &c.), equation (2), or into factors of N^2 , D , and $(A - B)$, as in L. A. Doggett's chart.†

The method of calculation adopted for the factor δk does not, in its present form, admit of its calculation for values of $l/D < d/D$, and it will be noted that

* E. B. Rosa, *loc. cit.*

† L. A. Doggett, *Electrical World*, January 31, 1914; *Electrical Review* (Lond.), LXXIV, p. 489 (1914).

SIMPLIFIED INDUCTANCE CALCULATIONS.

in consequence the k' curves as given do not extend beyond this value. This point corresponds to the square section coil, length=depth. Shorter coils may be calculated to a first approximation by interchanging l and d as indicated above. It is hoped in a later communication to deal with the extension of these curves to the smaller values of l by an alternative method of calculation.

6. Single-turn Rings.

Another use for these curves should also be noted—viz., their application to coils of very small section, down to the case of single turns of wire.

Taking the latter as an extreme case, it may be regarded approximately as a "square-section" coil of length=depth=diameter of wire. As an example:—

A single turn of wire of mean diameter $D=10$ cm. and wire diameter= 0.5 cm:—

$$l=d=0.5 \quad l/D=0.05=d/D.$$

$$\therefore k'=0.1015$$

$$\therefore L = \pi^2 \times \frac{10^3 \times 1^2}{0.5} \times 0.1015.$$

$$= 200 \text{ cm.}$$

The actual inductance of this ring=192.2 cm.

To render this method of calculation more easily applicable to these cases, a series of values of k' for very small values of l/D and d/D have been calculated. They are set out in Fig 3.

Note: Curve for Winding Depth=0 is Single Layer Coil Curve for Factor k.

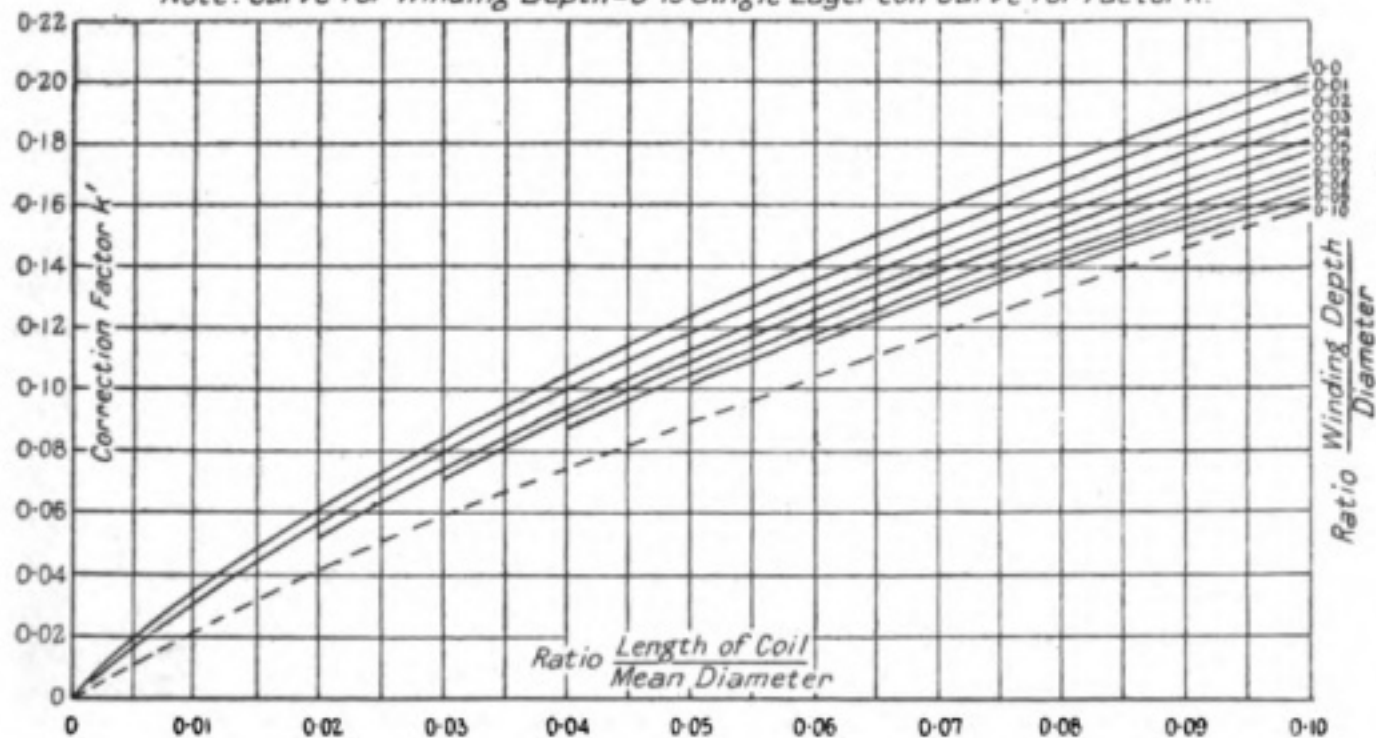

Fig. 3—Curves of k' for Coils of very small section (= Lower part of Fig. 1 to enlarged scale.)

These low-range curves of k' do not extend to values of l/D less than d/D , for the reasons already given.

In conclusion, it is hoped that this indication of a uniform and easy mode of calculation of the inductance of all ordinary shapes of coils may be of some utility in practical work, by limiting the number of formulæ to be memorised or to become familiar with, and thus leading to less confusion and error.

Digest of Wireless Literature

ON A NEW VALVE CIRCUIT FOR THE RECEPTION OF ELECTRIC WAVES.

By G. LEITHAUSER.

Jahrbuch der drahtlosen Telegraphie und Telephonie, July, 1919.

THE Audion of De Forest consists as is well known of a high vacuum bulb in which an electrically-heated filament emits a copious supply of electrons. The flow of these electrons to the positive anode can be controlled by varying the potential of the grid with respect to the filament. The early workers with tubes in which remained an appreciable amount of gas termed these instruments "Ionic relays," but latterly, when valves of the highest attainable vacuum are used, the term "Electron relay" is more appropriate. Although the early work with valves was directed towards the development of high-frequency amplification, experimenters during the war tended to work mainly at the problem of amplifying the audio-frequency signals obtained from a detecting circuit. The results obtained by this method really justified the amount of attention given to this problem. The normal method used was to include the primary of an iron core transformer in the anode circuit of the first valve and allow the induced voltage in the second coil to actuate the grid of another and so on.

Just at present, however, the problem of high-frequency amplification is again occupying a conspicuous place. Two types of methods of transferring the anode voltage variations of one tube to the grid of the next in a cascade of valves may be mentioned. The first consists in the use of air core transformers in the anode and grid circuits. An assembly of three valves in which the transference of energy from valve to valve is obtained in this manner is shown in Fig. 1.

The transformers must be so designed that the coils have only a small diameter,

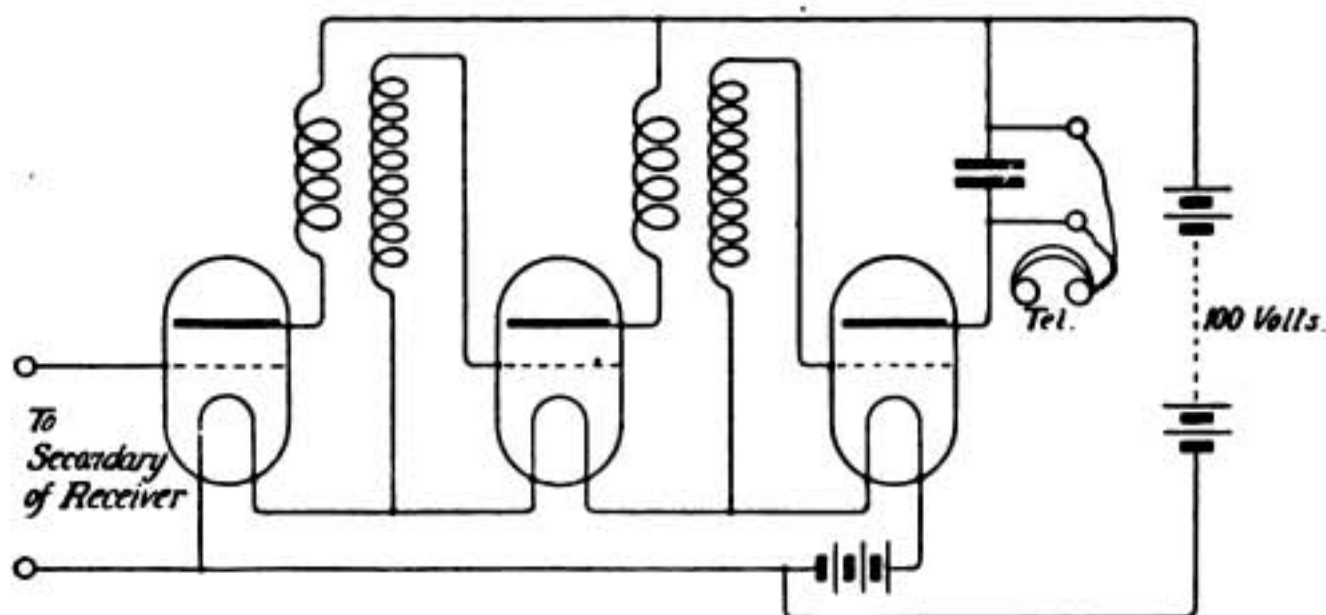

Fig. 1.

DIGEST OF WIRELESS LITERATURE.

as otherwise these act as direct receivers themselves giving rise to much troublesome interruption when signals from a very distant station are being received. In view of the fact that the spaces between the valve electrodes have high resistances the impedances of the transformer coils can also be made high. The magnitude of the impressed grid potential evidently depends on the magnitude of the anode voltage variations of the preceding valve; while the latter is dependent on the anode voltage, the anode circuit resistance, and particularly on the resistance of the transformer winding between the anode and the anode battery. In utilizing high resistances one would expect large variations of anode potential.

A second method of transferring the potential variations to the second valve (which first appears to have been used in America) consists in the use of a condenser C of small capacity (see Fig. 2.)

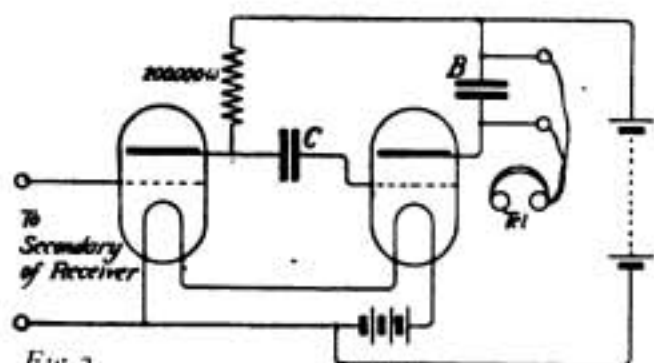

Fig. 2.

This condenser is connected on one side to the anode of the first valve and on the other side to the grid of the second. The second valve in Fig. 2 has included in the anode circuit a blocking condenser B to the plates of which the receiving instrument is connected in the usual way. As the transference of potential is brought about now by the condenser C we can replace the primary of the transformers of Fig. 1 by an ordinary ohmic resistance.

This usually is of the order of several hundred thousand ohms.

In the case of several tubes connected together as an amplifier with condensers to transmit the voltage variations from valve to valve and with an *inductive* high resistance inserted between anode and battery, we have an arrangement which is singularly sensitive and which can be brought to the point of instability by altering the filament current. In such a condition the amplifying power is enormous.

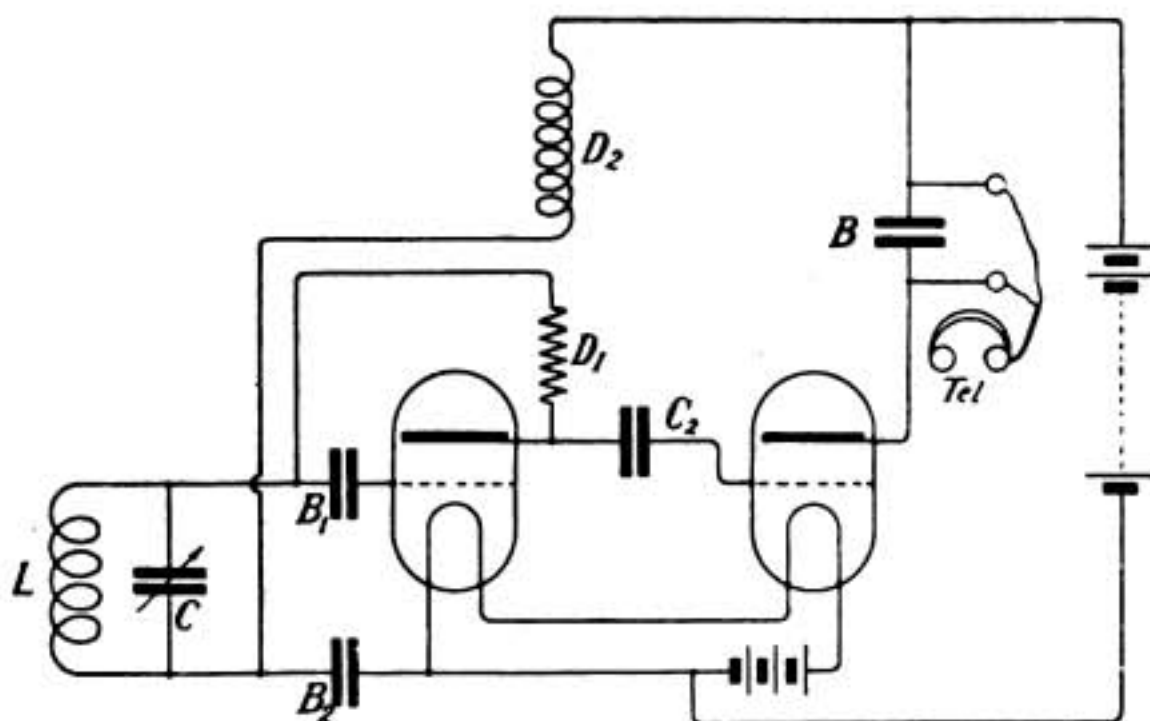

Fig. 3.

In fact it is over-sensitive, for if such an amplifier is brought near to the secondary circuits of a long wave receiver the coils of which have a diameter of say 20 cm, the energy transferred from these coils to the amplifier in the case of a neighbouring sending station is sufficient to produce signals, although the oscillatory circuit is not tuned to them. Also when situated quite free and not joined to a coil such an arrangement will reproduce the more powerful stations.

To remove this difficulty of interference the following arrangement has been evolved. It differs from the two circuits previously described in that the oscillatory circuit LC is connected to the anode of the first valve. This arrangement is shown in Fig. 3.

The oscillatory circuit is symmetrically placed with respect to the two high resistances D_1 and D_2 which are wound on bobbins of small diameter. The variations of potential across C are transferred to the grid and filament by means of the blocking condensers B_1 and B_2 . The condenser C_2 serves to transfer the variation of anode potential to the grid of the second valve.

This arrangement has been carefully tested and found to be extremely sensitive to waves of the same frequency as the LC circuit, but extremely insensitive to other frequencies.

THE PRODUCTION AND MEASUREMENT OF SHORT CONTINUOUS ELECTROMAGNETIC WAVES.

By DR. B. VAN DER POL.

Philosophical Magazine, July, 1919.

CONTINUOUS electrical oscillations of a wavelength of 6 metres have been obtained by W. C. White using a thermionic valve generator. By using a small hard receiving valve and similar circuit it has been found possible to obtain a wave length as slow as 3.65 metres. The circuit used is shown in Fig. 4, where P, G, and F represent the plate, grid, and filament respectively of the valve. The tuned plate circuit can be considered to consist of the wire P B C principally acting as inductance in series with the condenser C, and the capacity existing between the filament and plate. The grid circuit which is also tuned is formed by the wire G A F (which again principally represents the inductance) in series with the condenser formed by the filament and grid.

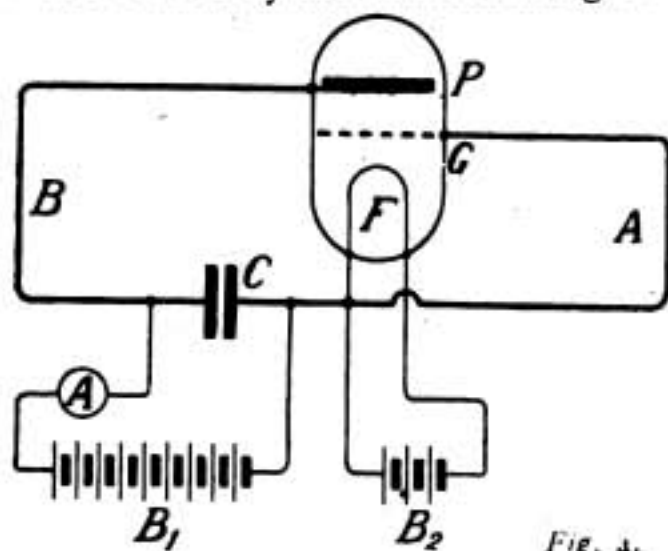

Fig. 4.

The necessary reaction from the plate circuit on the grid circuit is here obtained (instead of by the usual electromagnetic coupling) by a capacity coupling inside the thermionic tube, the grid being placed in the electric field between filament and plate. It happens that this coupling has the proper sign to maintain strong oscillations.

The wires P B C and G A F were each about 60 cms. long, while the connection C F was kept a few centimetres. The variable condenser C consisted of two circular metal plates

of 5 cms. radius, the distance between which could be varied.

How Aeroplanes are Navigated by Wireless

By R. KEEN, B.Eng.

THE Wireless Direction-Finder depends for its action on a property possessed by a frame aerial when used for reception, namely, that the current induced in the aerial is a maximum when the plane of the aerial coincides with the direction of the incoming waves and is a minimum when the frame is turned through a right angle. It will be seen, therefore, that if a frame aerial is made in the form of a rectangle and after being erected in a vertical plane is arranged so that it can turn about one of its vertical sides as an axis, the approximate direction of received signals can be found by swinging the aerial round until the noise in the telephone receivers is a maximum. This arrangement, however, is of little use in practice and a brief description will now be given of the Wireless Direction-Finder or Radiogoniometer as developed by the Marconi Company and which has proved of such enormous value during the war for the location of enemy wireless stations whether on land or sea or in the air.

Two frame aerials are used in this case and are either triangular or rectangular in shape. They are supported in a vertical plane and are arranged so as to be exactly at right angles to each other and symmetrical about a common vertical axis. The direction-finding instrument itself (D.F.) consists of two sets of field coils also arranged at right angles and a search coil which is mounted at the centre of these field coils and is capable of turning about a

vertical axis which is also common to the two field coils. The arrangement is seen fairly clearly in Fig. 1. The two aerials are connected in series with the two coils respectively, and the search coil is connected to the receiving apparatus which may be of any standard type although a valve amplifier is almost universally used. In certain types of D.F. the field coils are each wound in two halves and condensers are inserted at the mid points for tuning the aerial system to the wavelength to be received.

Now consider what is the effect of a wireless signal which is received on this

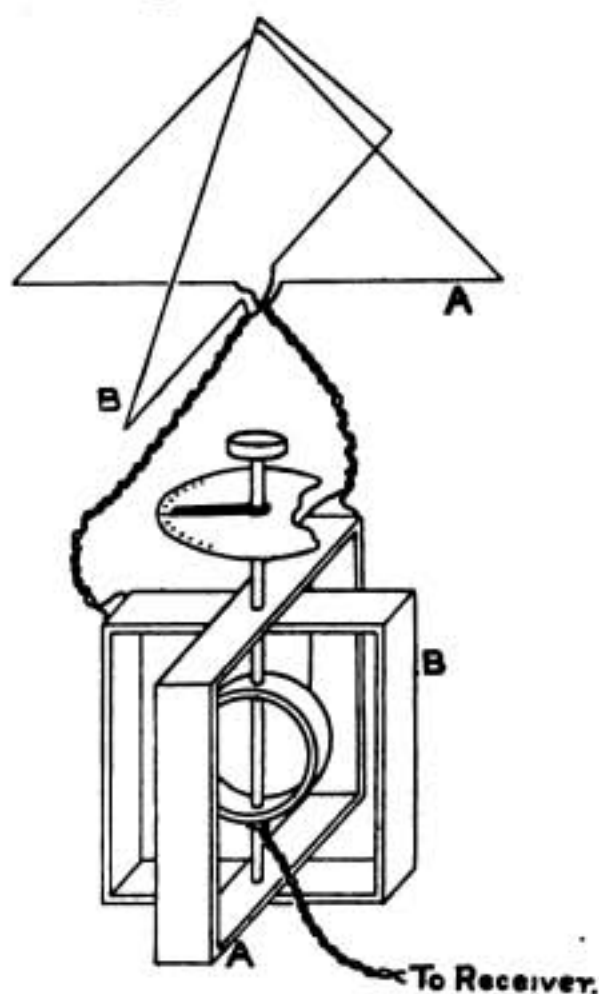

Fig. 1.

system. Suppose first of all that the signal is arriving exactly in the plane of the A frame (Fig. 1). In this case a current will be induced in the A aerial and hence in the A field coil and will produce a magnetic field along the cylindrical axis of the coil. On the other hand, in the case of a signal which is received exactly in the plane of the B aerial, a magnetic field will be produced along the axis of the B coil. If, however, the direction of the received signal is somewhere between the planes of the aerials, both aerials and hence both field coils will have currents induced in them and in the neighbourhood of the search coil there will now be two magnetic fields at right angles to each other, the relative strengths of which will depend upon which aerial is being affected to the greater extent. It can easily be shown that these two magnetic fields produce a resultant field which bears precisely the same space relationship to the axes of the field coils as the direction of the received signal does to the planes of the frame aerials. The problem remaining then is simply to ascertain the exact direction of this resultant field, and this is done by means of the rotating search coil. As the search coil is moved round, the signals in the telephone receivers are heard to rise to a maximum strength, which is when the maximum magnetic field is threading the coil, and to fall to zero on rotating the coil through a further right angle, in which case no magnetic flux is cutting the search coil. A pointer is attached to the spindle of this coil and a scale is fixed to the framework of the instrument so that the direction of the received signals, relative to the direction of the aerials, can be read off.

In the case of a land station the directions of the aerials are known and hence the bearing of any transmitting station can at once be found. On the other

hand, in the case of an aircraft installation, the positions of the transmitting stations on land are usually known and the direction-finder can then be used to measure the angles which these known stations subtend at the aeroplane from which readings the position of the aeroplane can readily be found.

It is impossible in the space of this short article to enter into details concerning the instrument or the precautions which must be taken in its manufacture and installation in order to obtain the great accuracy of which it is now capable, and we must now pass on to a description of how the exact position of a transmitting station is found by means of two shore D.F. stations and then to the methods employed whereby an aeroplane can be navigated entirely by means of bearings taken on distant wireless stations from the plane.

In Fig. 2, suppose X and Y to be two D.F. stations which have been carefully calibrated with respect to true North so that the direction which any incoming signal makes with the meridian can be found. It is required to find the position of some station Z. Both stations at X and Y stand by until they hear Z transmitting and then they simultaneously take his directions which are shewn as 110 and 45 degrees, respectively, East of North. These readings are then communicated to a person having a chart with the positions of X and Y marked and on plotting the two directions as shown by the D.F., the position of Z is at once seen to be at the inter-section of the lines. A serious difficulty arises here in the choice of a suitable chart to use for the purpose. The reader who is interested in the many different ways in which the curved surface of the earth may be projected in the shape of a map, in order to meet various requirements, is strongly advised to study the article on *Wireless Maps*

HOW AEROPLANES ARE NAVIGATED BY WIRELESS.

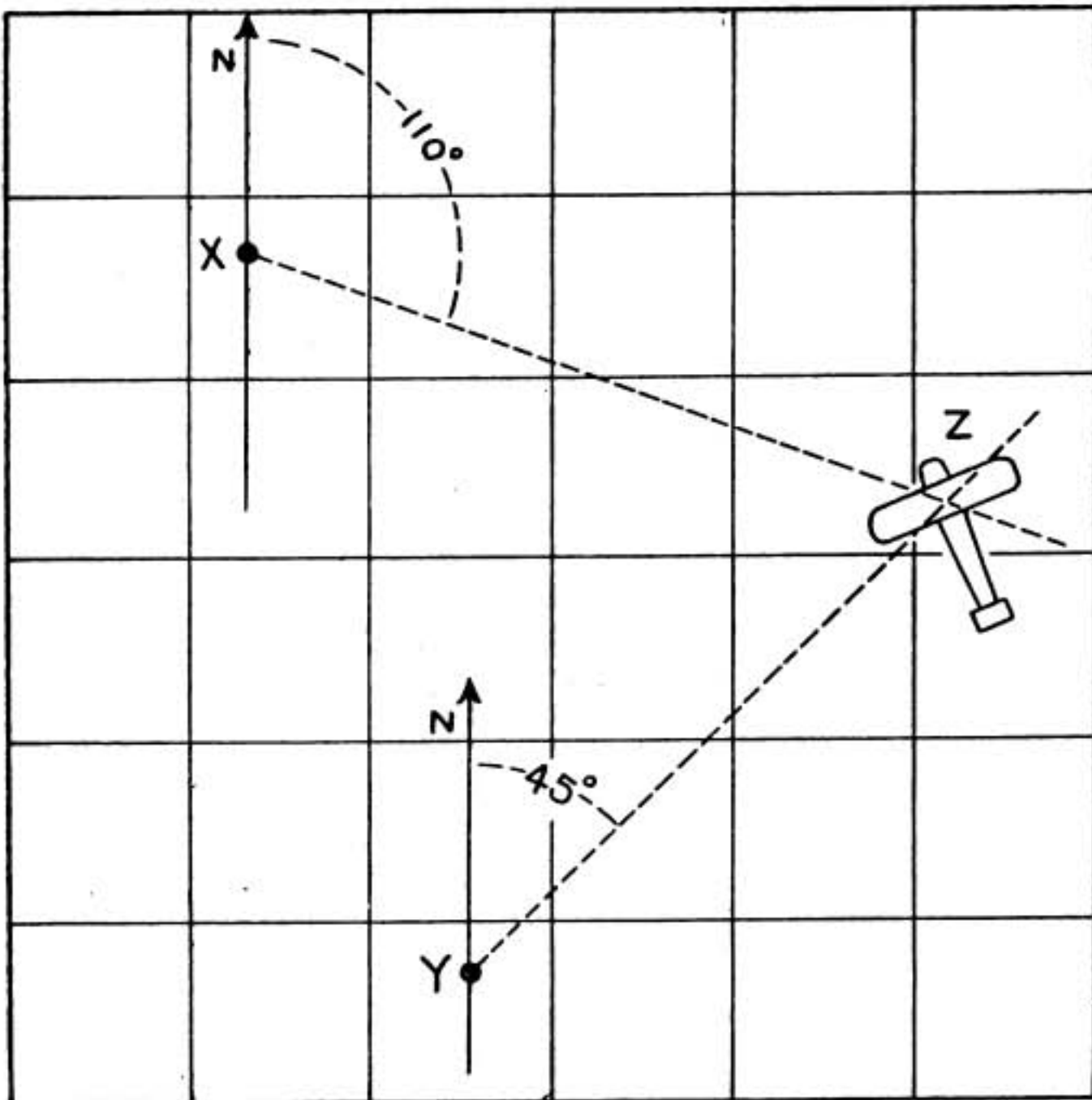

Fig. 2.

which appeared in the May issue of the **WIRELESS WORLD**. Some of the difficulties which are met with in long-range wireless direction finding will then be appreciated though they can only be very briefly dealt with here.

Owing to the curved shape of the surface of the earth, it is impossible to reproduce it on a plane without a certain amount of distortion. The wireless waves travelling from Z to Y in Fig. 2 do so along what is called the "great circle" through these points, and this is the shortest distance along the curved

surface of the earth, joining Z and Y. Since we are going to plot this direction on a chart by means of a protractor and a straight edge, it must appear as a straight line. Similarly, since we are measuring the angle which this line makes with the meridian through Y, it follows that the lines of longitude must also appear as straight lines. These conditions are complied with in a chart called a "Gnomonic Projection," but the parallels of latitude are found to be curves. If the more familiar "Mercator's Projection" be used, the lines of latitude and longi-

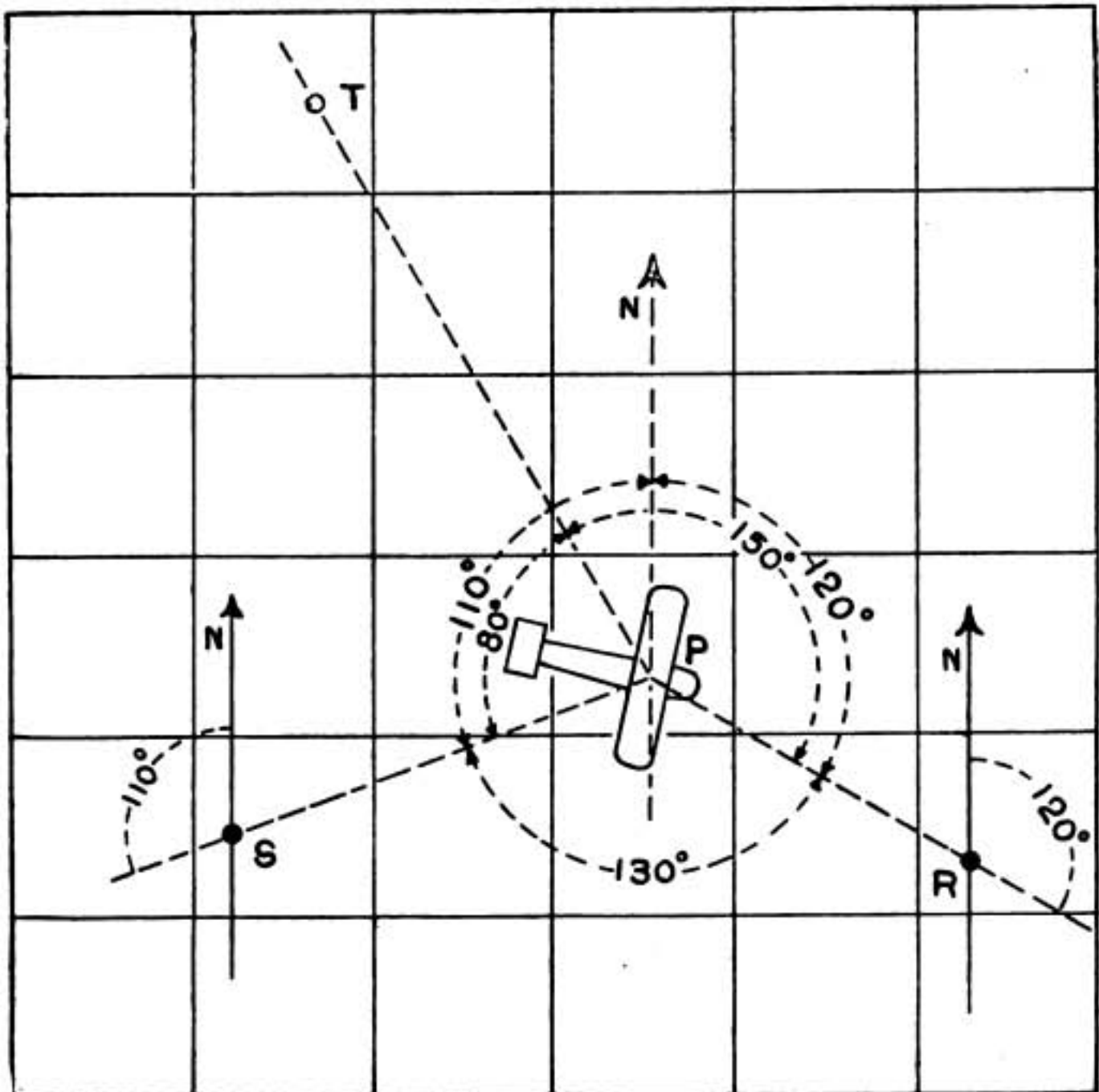

Fig. 3.

tude are straight but the great circles appear as curves and so on. For the purpose of this article it may be assumed that the distances apart of the stations are small so that an ordinary map may be used without appreciable errors; latitude, longitude and the direction of travel of the waves all being taken as straight lines.

Referring to Fig. 3, suppose P to be an aeroplane in flight which wishes to find its position with respect to certain shore transmitting stations which are within range. By means of the D.F.

the navigator takes the bearings of one of the stations, say R, and at the same time notes the magnetic compass bearing of the plane. From these two readings, after necessary corrections, the direction PR is found to make an angle, say, 120 degrees East of North. In a similar manner the direction PS may be found to be 110 degrees West of North. If these directions are now laid off on a chart from the points R and S, the position of the aeroplane must have been approximately at the point of intersection of the lines SP, RP when the read-

HOW AEROPLANES ARE NAVIGATED BY WIRELESS.

ings were taken. Allowance must be made for the distance travelled by the aeroplane during the process. If, for any reason, the magnetic compass is out of commission or is not trusted, the position of the aeroplane may be determined entirely by means of the D.F. by taking the angles subtended at the plane by any three transmitting stations whose positions are known. In Fig. 3 suppose T to be the third station. Readings are taken of R, S and T in rapid succession, and supposing the angles TPR, RPS and SPT are found to be 150, 130 and 80 degrees respectively, then by means of geometry or better still by the use of a "Station Pointer" the point P can be rapidly located on the chart. The instrument just referred to consists of a special form of protractor with three arms which can be adjusted to any angle. These arms are rotated until their directions represent the directions of R, S and T from P, and on placing the instrument on the chart so that the arms cut through the respective points, the centre point of the instrument shows the position of the aeroplane.

From these readings, not only the latitude and longitude of the aeroplane but also its direction of flight is found so that navigation can be carried out

accurately in almost any weather conditions. In the case of the transatlantic flight, the problem of navigating entirely by D.F. is particularly simple. Directly after leaving Newfoundland, an aeroplane is able to follow the great circle through the High Power transmitting stations at Glace Bay, Nova Scotia, and Clifden in Ireland. Signals from these two stations will therefore always be exactly 180 degrees apart on the D.F. Any "drift" on the part of the aeroplane will be at once detected by a change in the angle between the stations, and it is only necessary to alter course until the directions are again correct. By this means the shortest course is maintained with consequent saving in time and fuel.

With the development of commercial flying and the necessity of making long journeys to scheduled times and regardless of weather some method of navigation which does not necessitate a clear sky is essential and a great future for wireless navigation is already assured.

(In a future number we shall publish another article on the Wireless Direction Finder, dealing with the practical difficulties to be overcome in installing the system on aircraft, and giving our readers some ideas of the latest evolved form of the apparatus.)

WIRELESS AND LONGITUDE.

Under the auspices of the French Bureau des Longitudes, wireless telegraphy is shortly to be applied to a longitude determination of a complete circle of the globe. Three almost equidistant places have been chosen—Paris, Shanghai, and San Francisco—each separated from any one of the other two by approximately one-third of the earth's circumference. Accurate clocks

at these places will be compared by means of wireless signals from three other places—Annapolis, Honolulu, and a French Station are suggested—and as 15° of longitude are equal to an hour's time difference, instantaneous comparison of the clocks at the three places selected for the experiment will enable the differences of longitude to be accurately calculated.

“W/T. R.E.”

An Account of the Work and Development of Field Wireless Sets with the Armies in France.

By Capt. B. F. J. Schonland, O.B.E., R.E., late Staff Officer (Wireless)
1st Army, France.

(Continued from August Number.)

SPACE forbids my telling much of the minor communications which were provided by the ever-present C.W. set. Once we were moving forward rapidly it was impossible to provide the long telephone lines required by the anti-aircraft system, to link up “spotting” parties with guns, and guns with other guns. A big system of C.W. communication was therefore provided for “Archie”, and gave splendid service. The Royal Air Force, too, had a complete system of C.W. ground communications between Brigades, Wings and Squadrons. These did good work, but a description of their activities is not within the scope of these articles.

The retreat of the enemy in the opening days of November was marked by nothing if not by its celerity, and the corresponding speed of our advance led to a real clamour for wireless sets of all descriptions.

Requests were even received for wireless facilities for the use of R.T.O.'s. at railway stations! During the last few weeks of the war the aether in the zone of the British Armies was in a terrible state of agitation. Wireless sets with infantry, artillery, cavalry, tanks, armoured cars, scouts, anti-aircraft guns, all were working at red-hot speed.

And then, not unexpectedly, but suddenly all the same, so dramatic was its significance, came the message from the Eiffel Tower which rang down the curtain on the world-war. At 5 a.m. on

the morning of November 11th, when the operator on spark or C.W. set was drowsily wondering how soon the day's attack would mean another day's “S.O.'s.” and “D.'s.” came the message—“Marshal Foch to the Allied Commanders.—Hostilities will cease at 11 a.m.—.” That message was delivered in well over half the cases, delivered to the fighting troops by wireless. And in the tumultuous crash which followed, in the repetition of the message by the thousands of wireless sets in the army, one recalled another wireless message. Date—August 4th, 1914, a big German land station to ships at sea:—“War has been declared with Russia, France, and England, England, England, *England.*”

With the delivery of the orders for the armistice the real work of the W/T Section, R.E., was done. I cannot, however, refrain from recalling how, soon after eleven o'clock that memorable morning, direct communication was established by wireless between our G.H.Q. and our headquarters of armies, and those of the Germans. Messages were soon exchanged concerning the safe passage of German officers to arrange certain details of the armistice conditions, to hand over material, reveal unexploded land mines, etc. This direct communication between the two sides continued for some time. When our troops set off on their long march to the Rhine, great use was made of wireless sets of all kinds to provide communication between scattered units on

the move. Their success in that capacity is the last chapter in the history of the “W/T.R.E.”

The foregoing pages have attempted to present an account of the development of trench wireless, from the early sets on the Somme to the huge organisation, forming part of the Signal Service, and numbering some three thousand men and a hundred officers at the time of the armistice. I have tried to give the reader some idea of the results obtained, which exceeded the expectations of the most sanguine wireless enthusiasts. In an historical account it is difficult to find place for a detailed description of technicalities. This as well as an account of the difficulties and heroism of the operators, to whom all credit for success is due, I hope to treat of later, with some account of the work of Wireless Observation Groups, and listening sets.

The development of wireless with the army was far from reaching finality by November 11th. On the contrary, if the war had been further prolonged, a few months would have seen vast changes. The number of sets would have been doubled, perhaps trebled.

“Hullo Sparks! Got any messages through?” Sparks can afford to smile.

Having completed a brief historical account of field wireless sets with the

armies in France, I propose now to give the reader an idea of the various technical difficulties encountered and overcome.

It will have been seen from the maps given in previous articles, that the wireless communications were arranged on the “group” system. The arrangement for working and controlling the spark sets in an army corps are shown in Fig. 1. Each corps used one wavelength of the three—350, 450 and 550 metres

—available. Although this looks cumbersome on paper, in practice it was usually found that divisions such as those marked 49th and 32nd could carry out communication with brigade stations without interference. Any trouble, however, arising from jamming was attended to by the “directing” station concerned, divisional, corps, or army. The word of the “D.S.’s.” were also on the watch for carelessness in ciph-
-er-
-ing m e s -



A Trench Station.

sages and mistakes in procedure, as well as to assist with their more powerful sets, in case a brigade station could not be roused by its division.

Difficulties of manufacture delayed the production of an improved spark trench set, which would have made it possible to give each divisional group a separate wavelength and thus improve communication. Fig. 2 shows the al-

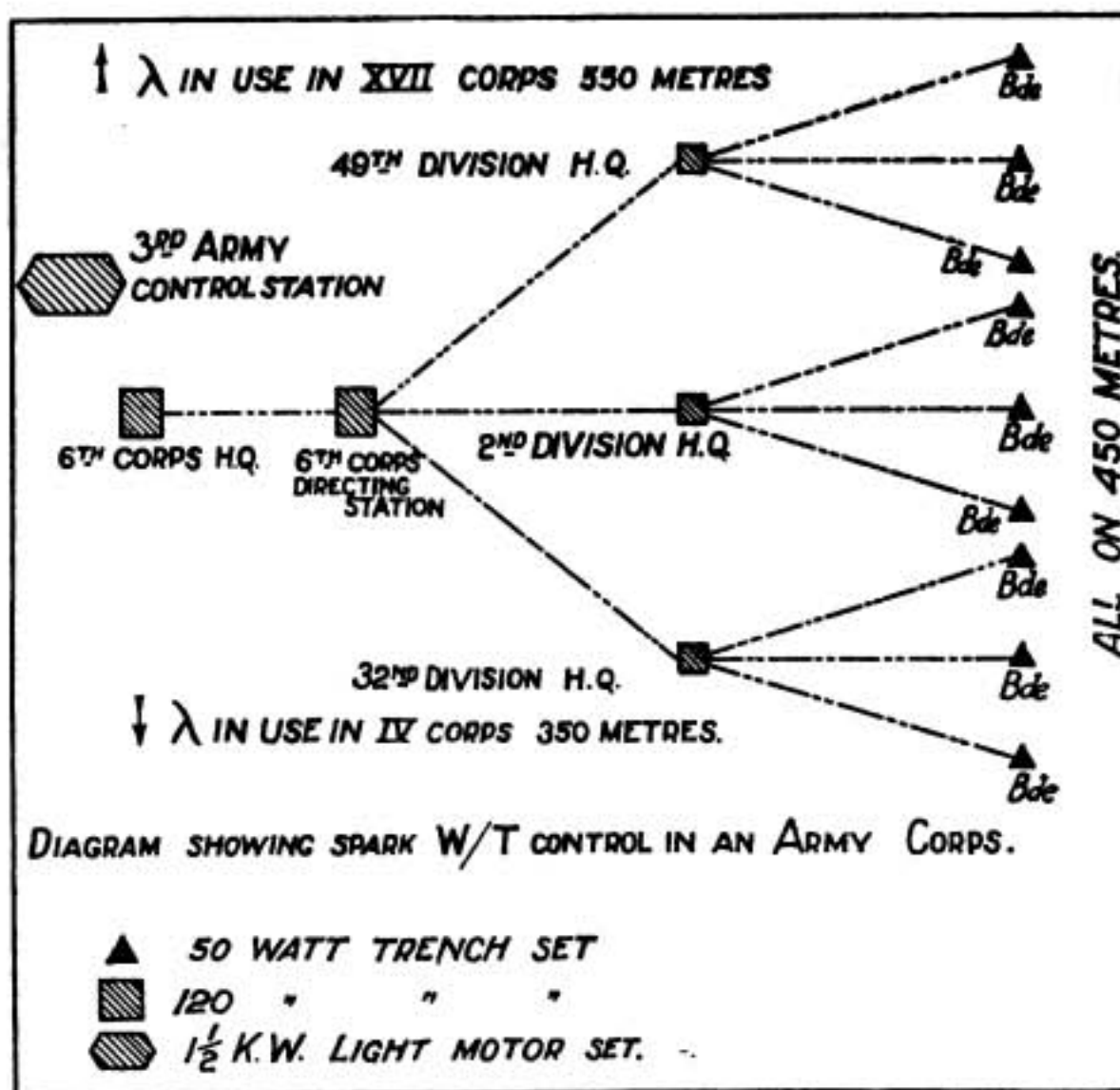

Fig. 1.

lotment of wavelengths amongst the various arms of the service.

The group system was also applied to C.W. sets with the artillery, though owing to the larger number of possible wavelengths (about thirty) the number of stations in a group rarely exceeded five. A complete scheme, involving "circuits" with only two stations using a particular wavelength, would have been introduced as more sets became available. Fig 3 shows a typical army corps C.W. system.

The C.W. wavelengths used by forward sets varied from six hundred to two thousand metres, though in general only 700-1,400 metres were employed in cases where short aerials had to be put up. Jamming from "550" spark sets troubled 600-700 metres C.W. if

used in the vicinity. It was, however, found possible to utilise wavelengths only twenty-five metres apart, for stations working in the same area. To ensure that the correct wavelengths were kept, a system of daily transmission of standard wavelengths from G.H.Q. or Army H.Q. was introduced, and standardised valve wavemeters were kept on every station.

During the last few months of the war so many C.W. sets were used that almost every available wavelength was in use. To control these stations adequately, and to watch their communication, would have required about thirty control stations. Though the Canadian corps, whose wireless was a model of efficiency and successful organisation, made a C.W. receiver capable of simul-

ALLOTMENT OF WAVELENGTHS AMONGST VARIOUS ARMS OF THE SERVICE

λ . METRES	SPARK USED BY	λ . METRES	CONTINUOUS WAVE USED BY
65 and 80	Loop sets	600—2000	Artillery
100—300	R.A.F.		Anti-Aircraft
350, 450, 550	B.F. Trench sets		Scouts and observing parties
600—1000	Tanks and Cavalry		Tanks
1100	G.H.Q. & Army H.Q.		R.A.F. ground stations

Fig. 2.

taneous reception on seven wavelengths, the general method employed was for the control station to search round each wavelength and listen in for so many minutes.

Jamming between the two systems, spark and C.W., in use in the same area was not excessive, provided two such stations were not very close together and that excessive C.W. ranges were not attempted. At the same time every C.W. operator breathed a sigh of relief when KBU (Bruges) ceased his activi-

ties on a thousand metres as a result of our Flanders advance last year.

Personnel and equipment of wireless stations were organised finally as wireless sections, forming part of the Signal Company with an Army H.Q., Army Corps, H.Q., or Divisional H.Q. Provision was made for the repair of instruments and the charging of accumulators with each of these units and in the end our wireless equipment was more than adequate.

(To be continued.)

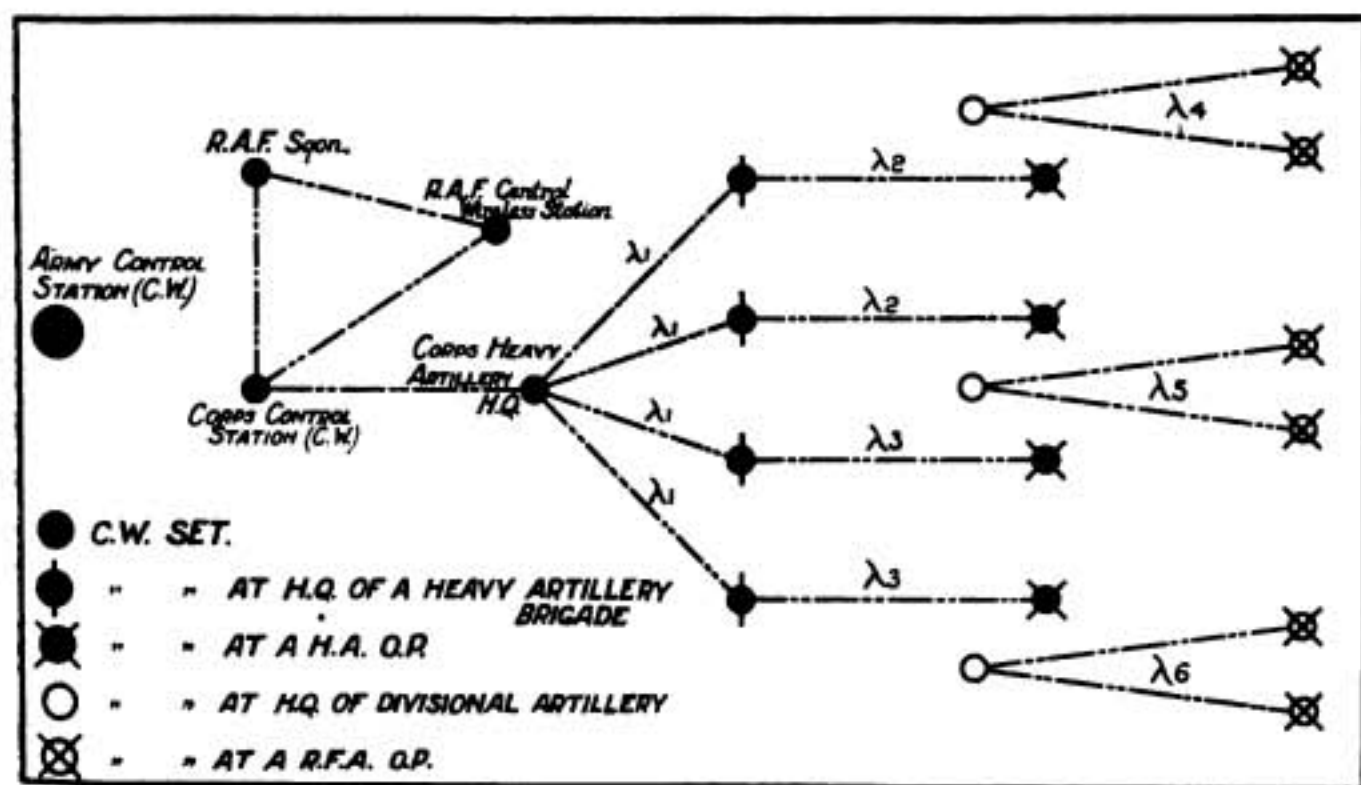

Fig. 3.

Stray Waves

WAR TIME DEVELOPMENTS OF THE NAUEN STATION.

At the beginning of 1914 this important German wireless station made use of 100 K.W. in the aerial with a musical note quenched-spark type of transmitter. After the outbreak of war the Sayville Station in America was called upon to handle an increasing volume of traffic. The original power of Sayville's apparatus was 35 K.W., but in 1915 a 100 K.W. high-frequency alternator was installed, enabling the traffic to be increased from 1.33 million words in 1915 to 2.58 million words in 1916. A further increase in power at Nauen then became necessary in order to overcome difficulties of working through atmospheric disturbances.

Two large antenna systems are provided—the larger being of T-shape, and the smaller in the form of an elevated horizontal triangle with the down leads from the apex. Simultaneous transmission on two different wavelengths is thus possible. The two main masts, of lattice construction, are 260 metres high, and are bedded on an insulating ball at the base. Additional insulation is provided at 150 metres from the ground. The supply alternator, single phase, can deliver 800-h.p., and after multiplication of the frequency by static frequency raisers, furnishes 24,000 amp current to the aerial. The wavelength is thus 12,500 metres. Transmission at 200 letters per minute can be carried on. The overall efficiency is claimed to be 65 per cent. from alternator to aerial at 12,000 metres wavelength.

The following table gives an interesting comparison with the installation in use in 1908:—

	1908		1918	
		Small Aerial	Large Aerial.	
Masts	1 of 100 m.	2 of 150 m. 1 of 135 m.	2 of 260 m. 4 of 120 m.	
Antenna area sq. metres	31,000	77,500	155,500 sq. m.	
Primary output K.W.	50	175	600	
Aerial energy K.W.	12	100	400	
System	slow spark	quenched spark	H. F. Alternator C. W.	
Range Kms.	3,600	8 000	20,000	

THE CYLINDRICAL ANODE.

We reproduce below a letter addressed by Mr. Godfrey C. Isaacs to *The Electrical Review* which appears in the issue of that journal for August 8th.

"In the very interesting article, 'Vacuum Valve Amplifiers,' published in your issue of June 27th last, you state that the vacuum-valves for the wireless telephone sets employed by the British service are 'based on the invention of Mr. O. B. Moorhead, of San Francisco, who holds an American patent for the cylindrical anode.'

"In connection with this I should like to draw your attention to the fact that my company was the first to introduce the cylindrical anode.

"Already in the first valve patent No. 24,850, of 1904, by Dr. J. A.

STRAY WAVES.

Fleming, the anode is shown in the drawing, and described in the specification as a cylinder.

"In so far as valves for generating purposes are concerned, my company's patent No. 28,413, of 1913, by H. J. Round, contains the following claim:

"A vacuum tube containing a hot filament, a grid formed as a closed cylinder surrounding the filament, and a third electrode in the form of a cylinder surrounding the grid."

"You will notice that Mr. Round's invention dates back to a time when the use of valves for generating was quite a novelty, and I do not think that Mr. Moorhead's patent (which, I believe, has not yet been published) could have been applied for at an earlier date.

MARCONI'S WIRELESS TELEGRAPH
Co., LTD.

(Sgd.) Godfrey C. Isaacs,
Managing Director.

London, August 1st, 1919."

• • •

THE SOLAR ECLIPSE AND WIRELESS TRANSMISSION.

As a result of certain observations made during the solar eclipse of May 29th last, further evidence is forthcoming with regard to the phenomena of day and night wireless signalling. Under normal conditions the wireless station at Meudon, Paris, is unable to receive daylight signals from Ascension, but can do so during the hours of darkness. During the eclipse, which was not visible in France and only partially visible in Ascension, special tests were made between the two stations, and it was found that whilst the moon's shadow passed between them Ascension was quite audible at Meudon, the signals failing as the shadow passed away. This may be taken as additional proof that the increase in the distance at which

a given transmitter is able to affect a given receiver as a result of nightfall, is due to the diminution of the effect of solar radiation on electro-magnetic waves.

• • •

SIDELIGHT ON THE NEW W/T BILL.

The Somerleyton Merchant Shipping (Wireless Telegraphy Bill) enacts that vessels of 1,600 tons and over shall be fitted with wireless apparatus. Smaller vessels are exempted and one can only conclude that the Government has paid more attention to the outcries of the owners of the coastal shipping than to the basic idea that it is worth while preserving human life—anywhere. One day ship-owners will be compelled to provide every possible precaution against loss of life, just as are factory-owners; meantime seamen wrecked on small boats must swim for it. We note that the Grimbsy trawler, *Sun Cloud*, is supposed to have been lost with all hands in the North Sea, and that if such is the case her crew of ten leave behind them sixty-six children. *The Sun Cloud was not fitted with Wireless.* We seem to smell strikes amongst seamen, especially trawler fishermen.

• • •

In the article entitled "The New Wireless Service on the Island of Borneo," published in our August number, the author states that up to last year the Indo-Malay Archipelago did not possess any radiotelegraph station. It should be pointed out, however, that the Sandakan and Jesselton stations were working as far back as 1913, and those at Tawao and Kudat since 1915, all having been of much Imperial and local utility.

Wireless Telegraphy Problems for Operators

By W. H. ECCLES, D.Sc.

This is the concluding portion of the article specially written by Dr. Eccles for intending competitors in our Competition for Commercial Wireless Operators.

(See page 330 of September Number.)

Variations Due to Geographical Features.

OF these there are two kinds which we may say have been widely accepted as genuine; these are land shadows and, second, the easy transmission along river valleys. On both these more information is wanted. Land shadows are perceived in several ways. For example, a ship on the Cape route, when rounding the great bend of West Africa, gradually brings land between various European stations and itself. The problem of measuring the change in signal strength produced by this cause is complicated by the fact that the ship's distance is also increasing. However, this can probably be allowed for if a sufficient number of observations are made on successive trips. Other land shadows are produced by mountain ranges and should be observed and measured up. There are obvious practical applications here in the way of determining the power of a station for a new job.

The valley phenomenon is the converse of the shadow. For example, the Eiffel Tower Station is said to be received better in parts of the Mediterranean when the waves find their path lies down the Rhone valley than when they have to pass over even slightly

hilly country. The Mississippi valley is said to have the same effect.

The whole question of how much better transmission is over water than over land is still open for the experimenter. Any voyage through the Mediterranean gives opportunities for examining the matter, and similar opportunities must often arise on other voyages.

The Problem of the Directive Aerial.

A problem that calls for investigation is: How far do the directive properties of such an aerial as that at Carnarvon persist? Theorists have argued that at a very great distance the strength of signals should be equal in all directions; the writer's own observations on various Atlantic trips show that the directive properties are decidedly pronounced at distances of several hundred miles. But much more investigation is needed.

Apparatus for Measurement of Variations of Signals.

It is obvious that the results obtained from any of the above suggested observations will be the more valuable the more quantitatively they can be made. One way of measuring signal strength is by the shunted telephone method. This is very rough and very frequently does little more than esti-

WIRELESS TELEGRAPHY PROBLEMS FOR OPERATORS.

mate the variations of the sensitiveness of one's own detector and hearing. The writer has used in preference the following simple method, which evolved itself gradually from a much more complicated collection of apparatus during a voyage across the Pacific when one part after another went wrong and could not easily be properly repaired. It gets over the difficulties which arise out of possible variations of sensitiveness of the receiving apparatus, and of the operator's ears.

The circuits are explained by Fig. 1, where *A* is the antenna, *L* a loading coil, *M* a small coil inserted in series with the antenna, and *k* the coupling coil leading to the detector circuits. The coil *M* is included in a circuit which can be impulsed to a variable extent. The variation is effected by having in the circuit a variable resistance *R*. Impulsing is done by means of a buzzer,

which in the Figure appears to be of rather special kind because the contact it opens and closes is carried on a piece of insulation which separates the impulsing circuit completely from the driving circuit of the buzzer. The voltage for impulsing is supplied by two or three dry cells at *E*. When the buzzer is working, an interrupted current is sent round the circuit *ERM*, and at each break the antenna is set into oscillation. If spark signals are being listened to the buzzer ought to be made to give nearly the same note as the signals. Then if *R* is made big it will be found on pressing the key *K* that very weak sounds from the buzzer become mixed in with the signals being received. When *R* is made relatively small, strong sounds come to the telephones through the receiving apparatus from the buzzer when *K* is depressed. There is an adjustment of *R* at which the locally-made signals are

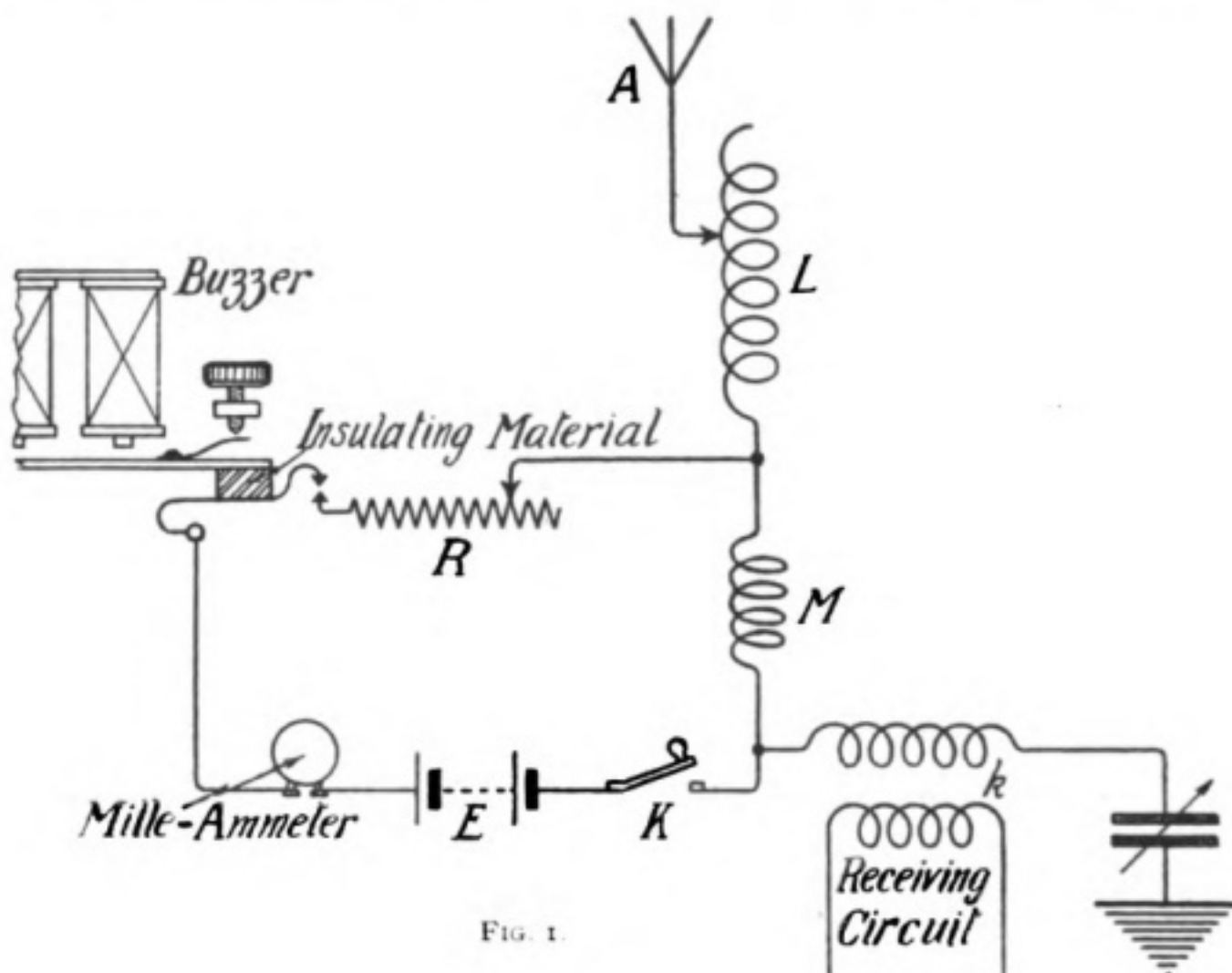

FIG. 1.

equal in strength to the incoming signals. This matching of the sounds can be carried on in spite of the presence of strays, engine and water noises and conversation, features which cannot be claimed for the more frequently used shunted telephone method. The result obtained is chronicled by closing the vibrating contact and the key K for a few seconds and reading the milliammeter. I have found the best variable resistance consisted of a glass tube 18" or 2 ft. long and $\frac{1}{4}$ " to $\frac{1}{2}$ " internal diameter, sealed at the bottom by a fixed cork through which a fixed electrode of copper wire passes into a 5 per cent. solution of copper sulphate nearly filling the tube. A second copper electrode enters the top of the tube through a perforated cork and can be pushed up and down so that its lower end can be immersed at different depths in the liquid. Better results are obtained if all of this conductor except about $\frac{1}{4}$ " at the lower end is covered with an insulating material. At sea the writer has used a piece of ordinary gutta-percha-covered wire straightened carefully as the variable electrode. At sea one makes in case of necessity further simplifications in the whole method; for example, if necessary, sea water can be used instead of copper sulphate for quick measurements. Then again the milliammeter can (if need be) be dispensed with by graduating the copper tube and recording the results of observation by measuring the lengths of the copper sulphate column used in balancing the sounds. At a pinch, one may even do without the buzzer, for one may impulse the antenna by drawing a piece of copper wire forming one end of the circuit across a fine file forming the other end of the circuit, so that the interruptions of contact thus produced give a note of about the pitch of the signals. The coil M inserted in the antenna need only be

some 40 turns, 4" diameter, of copper wire. These makeshift arrangements are not mentioned here to encourage observers to be content with makeshifts, but merely to show that lack of elaborate apparatus is no bar to making measurements of quite a reasonable order of accuracy in this branch of our subject.

The circuits suggested in the Figure are susceptible of many small changes without modifying their action; for example, the key K may if desired be put in the driving circuit of the buzzer so that the buzzer need not be kept going continually.

Observations of Strays.

Strays are natural electric waves travelling about the globe which seem to be classifiable into three types. The Radiotelegraphic Committee of the British Association gave these types the name "clicks," "grinders" and "hissing." When in mid-ocean one hears the "hissing" type one can be pretty sure of seeing, if it is daylight, a white squall within a few miles. This type is accompanied by continuous discharge down the antenna. It offers little opening for study except to operators interested in meteorology. The "clicks" have long been thought to be due to lightning discharges. Dr. de Groot, working in the Dutch East Indies, gives evidence for believing that the clicks originate in lightning discharges in the lower atmosphere. He claims also to have shown that the "grinders" are produced by electrical discharges in the upper atmosphere provoked by the bombardment of these upper layers by something from outside the earth. He puts these layers at about 100 miles high and thinks that any particular station receives its grinders from a comparatively small angular area vertically above it. In 1913 Mr. Ricci, a Marconi operator working for the British Association

WIRELESS TELEGRAPHY PROBLEMS FOR OPERATORS.

Radio Committee, brought home records from several round-the-world voyages showing that in the middle of every ocean when the distance from land was very great in every direction there were very few X's, either grinders or clicks, at any time of the day. This fact seems to indicate that Dr. de Groot's hypothesis is not acceptable in its entirety, for evidently cosmic bombardment ought to be quite independent of whether the observer is on land or at sea.

Again, everyone who has listened regularly in the telephones knows that X's grow rapidly worse as the ship approaches the edge of a Continent, and this more particularly if the land rises rapidly from the sea to great heights. No doubt the direction of the wind must have some bearing on these phenomena, for in all probability the X's are in this case largely due to the uprush of air that is always taking place on mountain ranges.

Conclusion.

The above paragraphs indicate broadly some of the main areas in which wireless investigation is needed. Having regard to the individual character of the

researches contemplated in the present enterprise of the WIRELESS WORLD it is unnecessary, and is perhaps inadvisable, to lay down any definite scheme of work. By leaving everyone free to choose his own problem and his own method of attacking it, the fullest scope will be offered to originality, and discoveries may be made that might not have been embraced by any formal scheme. It may be encouraging to beginners to remark that in the actual carrying out of such investigations as are here contemplated the qualities of mind that count most are, probably, alertness, acuteness and accuracy of observation, together with judgment. Persons highly endowed with the above observational faculties can discover new features in old fields—features which when pointed out by the discerning mind become plain enough to everyone, including those who previously overlooked them. But judgment also is valuable, for without it the investigator is often finding something that really isn't there and is continually being tricked by his apparatus and his senses and being deceived by the wiles of Dame Nature.

COMPETITION FOR WIRELESS OPERATORS.

THE article written by Dr. Eccles, which is concluded above, throws out hints as to the manner in which commercial W/T operators may engage in wireless research work without interfering with their duties. Intending competitors should read pages 330-332 of our September number and decide upon what line of work they can best take up. The results of their work are to be submitted in the most appropriate form not later than January 7th, 1920. The prize-winners will be selected by Dr. J. Erskine-Murray and the joint editors of

the WIRELESS WORLD, preference being given to the papers which are considered to be the most useful contributions to knowledge of the subject.

First prize, Twelve Guineas; second prize, Six Guineas; four consolation prizes, each consisting of Dr. Fleming's new book, *The Thermionic Valve and Its Developments in Radio-telegraphy and Telephony*, and Mr. Philip R. Coursey's *Telephony without Wires*.

Full details and the rules of the competition will be found in the September number.

Notes of the Month

R.A.F. WIRELESS DEMONSTRATION.

ON August 11th a demonstration of Wireless Telephony was given by the R.A.F. in a Committee room at the Houses of Parliament. We understand that General Seely disclosed that the invention of continuous waves, and the valve in place of the coherer, made wireless telephony possible early in 1915. Somewhat earlier than that, we believe,—but what have the magnetic detector and the crystal done to escape honourable mention in respect of the evolution of detectors?

SOMERLEYTON WIRELESS TELEGRAPHY ACT.

On August 15th Royal assent was given by Commission to Lord Somerleyton's Merchant Shipping (Wireless Telegraphy) Act.

WIRELESS METEOROLOGICAL SERVICE.

An Admiralty Notice to Mariners (1393 of 1919), regarding wireless meteorological information to and from ships at sea states amongst other things that it is earnestly hoped that all concerned will assist in making the Wireless Meteorological Service a success. Negotiations are now in hand to extend and unify the system of collecting weather data by wireless from ships at sea all over the world, and to organise the free transmission of weather bulletins from a sufficient number of wireless stations to admit of ships being con-

stantly supplied with reliable weather reports and forecasts wherever they may be. It is hoped that the messages will eventually be made in an International Code at fixed times so arranged that a ship with only one wireless operator will be able to read them.

The note previously appearing in regard to the British Stations at Poldhu and Cleethorpes to the effect that these stations "would be started shortly" is now deleted, and the stations are given as working. The station at Washington now issues bulletins at two fixed hours of the day instead of only one. New weather-reporting stations are notified as established at Annapolis, U.S.A., and for the Mediterranean at Binella.

WIRELESS STATION FOR WARSAW.

It is understood that the Polish Government is considering the establishment of a powerful wireless station near Warsaw and negotiations are being carried on with representatives of various nationalities, including American and German engineers. It is stated that the German Government has offered to construct the station for a figure some eight times lower than that quoted by other European countries.

WIRELESS AND METEOROLOGY.

Arrangements have been made to hold a conference of representatives of the Meteorological Services of the British Dominions in London from September 23rd to 27th.

NOTES OF THE MONTH.

The subjects to be considered will include:—

- (1) The meteorological arrangements for the exchange of observations by wireless at comparatively long distances. Specification of observations for the surface and the upper air, with the codes for transmission.
- (2) The consideration of instruments and material for the investigation of the upper air.
- (3) The selection of stations of the Reseau Mondial for the purpose of the general climatology of the globe. (See Reseau Mondial 1911-12-13, M.O. publication 207 g., 209 g., 214 g.)
- (4) The provision of current meteorological information for the main air routes of the world; co-operation in the investigation of the meteorological conditions of aerial navigation.
- (5) The Trade Routes and the meteorological survey of the oceans by observation transmitted by radio-telegraphy from ships.

• • •

WIRELESS CLUB NOTES.

THE WIRELESS SOCIETY OF LONDON.

THE Committee of the Wireless Society of London met on July 24th under the Presidency of Mr. Alan A. Campbell Swinton, F.R.S., with a view to an early resumption of activities. The Hon. Secretary, Mr. R. H. Klein, having resigned, and having been elected an acting Vice-President, Mr. Leslie McMichael of 30 West End Lane, West Hampstead, N.W. 6, has been elected Hon. Secretary and to him all communications should be addressed. Intending new members, and those who were

members at the outbreak of war who have changed their address, are requested to communicate with the Hon. Secretary.

The Society is at present in communication with the Post Office on the subject of licences.

The finding of new Club rooms is engaging the attention of the Committee, and it is hoped to secure premises where the wireless equipment of the Society can be installed and used.

A General Meeting will be held in a few weeks' time, of which due notice will appear in the Press and will be sent to members and those who anticipate becoming members.

We understand that the officials of the Society are in close touch with St. Martins le Grand on the question of licences. It will be remembered that before the War they appointed a strong advisory committee to assist the officials of the Post Office in sifting their numerous applications for licences and recommending those which should be accepted.

The Honorary Secretary informs us that the offer of their services has again been accepted in the same capacity. Several questions in connection with the proposed new licences have still to be decided, particularly with respect to transmitting, but we gather that the genuine experimenter and the amateur, who is prepared to conform to reasonable regulations, may rely upon the Society doing all that can be done at the moment to further their interests.

• • •

WIRELESS AND EXPERIMENTAL ASSOCIATION, LONDON.

The Wireless and Experimental Association's meeting every Wednesday at 16, Peckham Road, S.E., at 7.30 p.m. is now in full session. As its name implies guidance is given to members who wish to construct their

own apparatus. Lectures are arranged and interesting experiments are to be carried out. As soon as the P.M.G. can be persuaded that we have no designs detrimental to the Stability of the Realm or the Ether, we shall get our licences for working on a short wavelength, so keeping bright the skill which we acquired during the war and placed at the service of our country. "For we are all honourable men," and the land we defended against Teutonic aggression we now desire to decorate with graceful festoons of copper wire.

Mr. Gribble, the Secretary, will be pleased to receive applications for membership from all interested, welcoming more particularly ex-service men with experience.

• • •

THREE TOWNS WIRELESS CLUB.

The report of the meetings of the above club during August is as follows: *August 15th.*

Members of the Three Towns Wireless Club met at Plymouth Chambers. Mr. J. Jerrett was Chairman. It was decided to try and shake up our splendid Government re. restrictions on Wireless telegraphy for the so-called amateurs, many of whom were proficient enough to take charge of wireless installations in the Royal Flying Corps and in many other spheres when we were at War. Many of them desire to get on with their experimenting, now that they are no longer required. A protest has been sent to the P.M.G. and a hope was expressed that other clubs would follow suit.

August 22nd.

Mr. Voss gave an interesting and instructive lecture dealing with ether waves, sound waves, light waves and wireless waves. He explained how each kind penetrated various substances. The spectrum and X-

rays were also dealt with. Mr. Jerrett, the Chairman, complimented Mr. Voss on his able address. It was also decided to hold a field day at Saltram Park, with Lord Morley's permission on Saturday, September 6th.

August 27th.

An interesting and instructive lecture was given at the Club headquarters by Mr. Lock on Detectors past and present. The oldest Detector is the eye. Then came mechanical ones, the Hertz Detector, Branly Coherer, Sir Oliver Lodge's Coherer, Marconi's Sealed Coherer, Marconi's Magnetic Detector, Various Crystal Detectors, Electrolytic Detectors, Fleming's Valve on which principal all the valves work up to the present day. All were dealt with in an able manner, and illustrated with models lent by Mr. J. Jerrett, and specimens brought by the lecturer himself. The lecture was thoroughly enjoyed by all present. A vote of thanks was given Mr. Lock for his kindness.

The Hon. Secretary will be pleased to see anyone wishing to become a member at 1 Brandreth Road, Compton, Plymouth.

DIRECT WIRELESS SERVICE BETWEEN HOLLAND AND DUTCH EAST INDIES.

Stations are now in course of erection to provide for the direct transmission of wireless messages from Apeldoorn (Gelderland, Holland), and the Dutch East Indies, a distance of 11,000 kilometres.

• • •

THE LA CROIX D'HINS WIRELESS STATION.

This station which is in course of construction and which it is hoped will be completed within six months will be one of the most powerful in the world. The mast and aerial system will consist of eight steel masts 250 metres high and an antenna 1,200 metres long.

Notes on Valve Amplification

By W. S. BARRELL.

AFTER having briefly outlined the theory of valve rectification we will now proceed to deal with valve amplification. This important function is greatly utilized in up-to-date receivers, and has made long-distance reception much more practical and simple.

In pure valve amplification current variations in the grid circuit can be reproduced on a magnified scale in the anode circuit, and the following case is given as a simple example: In Fig. 1 is shown a step-up transformer *S*, the secondary of which has one end connected to the grid of the valve, the other end being connected to the potentiometer slider *P*; a pair of telephones is connected as usual in the plate circuit. Suppose a telephone to be connected to the primary of the transformer *S* and a watch laid on one of the earpieces. By correctly adjusting the position of the potentiometer slider magnified ticks will

be heard in the telephone receivers. Here then is the case of the valve acting as an amplifier.

If the amplification given by the above scheme of connections is not sufficient it can be increased by adding another valve. The telephone receivers should be replaced by another step-up transformer, the secondary of which is connected to the second valve in precisely the same manner as the first one shown in the figure. The first would be styled a single and the latter a double amplifier.

The reader is now referred to the characteristic curves shown in Fig. 2. That the effect of current in the grid circuit is to damp out part of the oscillations has already been shown, and when used as an amplifier the valve should be worked at such a point that the grid current is zero. Reference to Fig. 2 will show that between the points *A* and *B*, although current is flowing in the anode circuit the grid current is

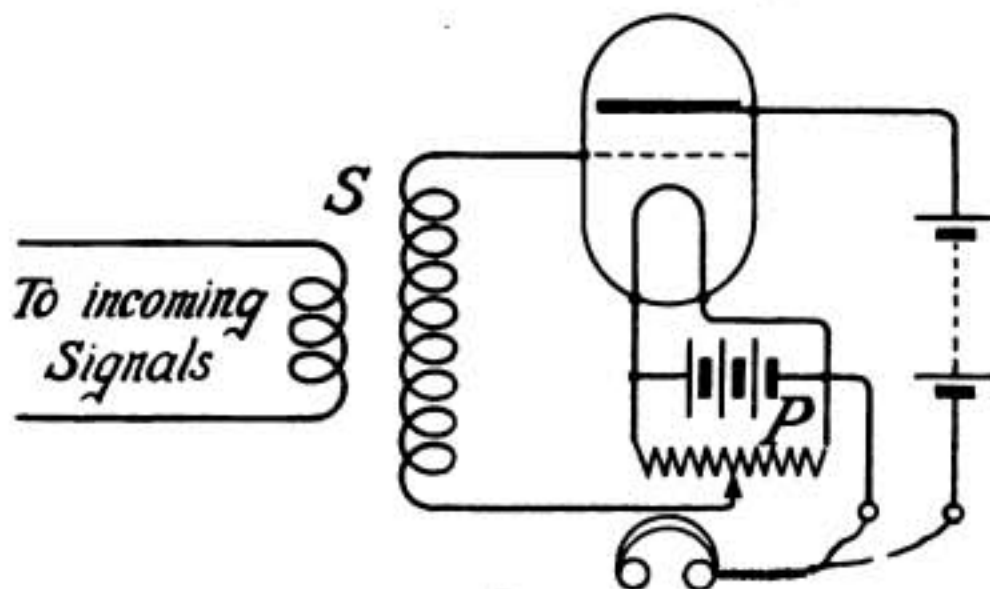

Fig. 1.

zero. For amplification, then, the valve must be worked somewhere between these limits. Suppose the normal grid potential to be adjusted to the point C. Variations in the grid circuit will cause similar but amplified variations in the anode circuit, or, in other words, the conditions in the grid circuit are repeated on a larger scale in the anode circuit.

The anode-current-grid-voltage curves shown in Fig. 2 will now be studied a little more closely. Commencing, first, with the lower one, and, assuming that we are working with a normal grid voltage C a given voltage variation about this point produces a certain variation in the anode current. Working at

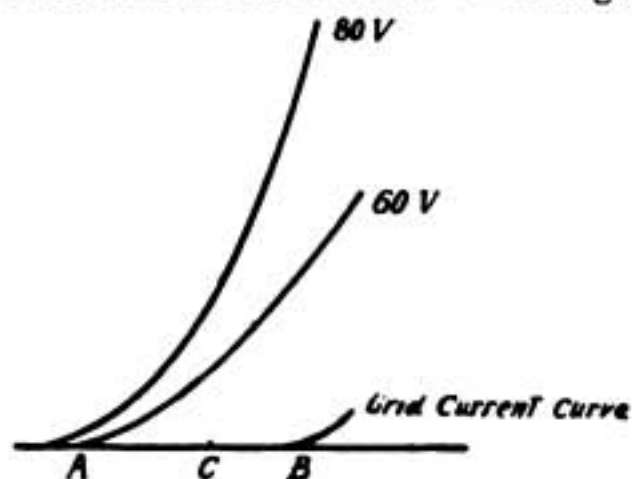

Fig. 2.

the same point on the upper curve it is seen that the same voltage variation produces a much greater anode current variation. That is to say, the steeper the curve the greater the change in the anode current for a given change in grid voltage. Now Fig. 2 shows that the characteristic is steepened by increasing the plate voltage, other things remaining constant. Theory therefore indicates that the magnification should increase with an increase in plate voltage, and Fig. 3 shows how this is borne out in practice. It will be seen that up to a certain point the magnification increases with increase of anode voltage, finally reaching a steady value, after

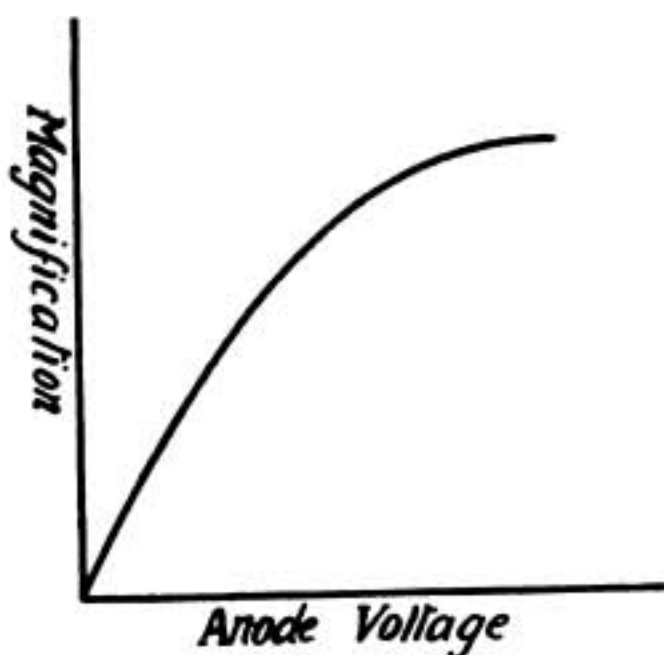

Fig. 3.

which an increase in plate voltage produces but little increase in the amplification. That the magnification is also a function of the filament current would also be expected since the slope of the anode characteristic depends upon the filament current, other things remaining constant. Fig. 4 shows how this assumption is confirmed by practice. In this case filament current has been plotted as abscissæ and magnification as ordinates. It will be noticed that the curves in Figs. 3 and 4 are similar in shape, both rising very rapidly at first, finally approaching a steady value.

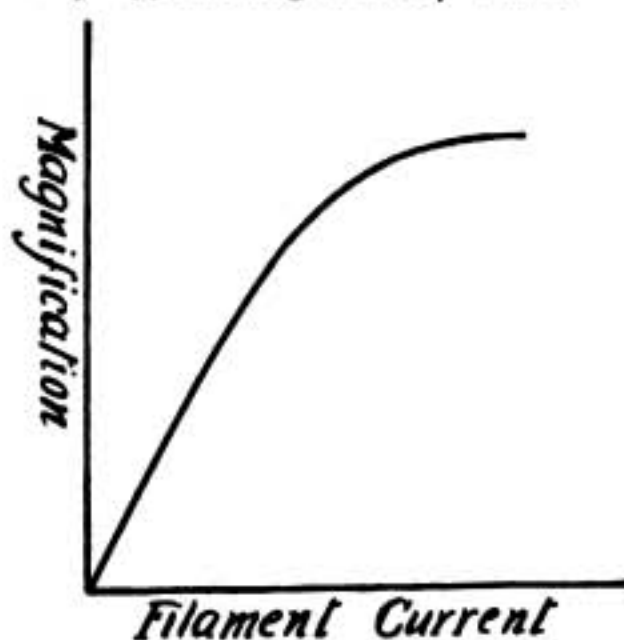

Fig. 4.

NOTES ON VALVE AMPLIFICATION.

The magnification given by any valve is, of course, primarily dependent upon its design and mechanical dimensions, but for any valve the optimum magnification possible can be obtained by careful adjustment, as is seen by the curves in Figs. 3 and 4.

The amplification of any particular valve can be easily determined as follows: First, draw the ordinary anode-current-grid-voltage characteristic curve using the value of plate voltage it is in-

tended to employ in actual practice. Determine the slope of the curve at the normal grid voltage to be used. This will give dl/dv which we may call X. Now draw a curve plotting anode current against *anode* voltage. The grid voltage must, of course, be kept constant and should be the same as that at which the slope of the anode characteristic curve was taken. The slope of this second curve = $dl/dV = Y$. and $\frac{X}{Y}$ = maximum voltage amplification.

THE BRITISH ASSOCIATION.

The annual meetings of the British Association have now been resumed after a lapse of three years, in the gathering held at Bournemouth from September 9th to 13th.

The inaugural address by the President was delivered by the Hon Sir Chas. A. Parsons, K.C.B., M.A., D.Sc., F.R.S., and dealt with a number of interesting points in connection especially with wartime developments in various branches of Science and Engineering. Particularly interesting details were given of the energy involved in various forms of artillery warfare; and in the large increases in the sizes of modern machinery. In the Engineering and Physics Sections of the meeting several papers were presented of particular wireless interest. Among these may be mentioned:

"Directional Wireless, with special reference to Aircraft," by Capt. J. Robinson, R.A.F.

"Wireless in the Royal Flying Corps," by Major Vincent Smith, M.C.

"The Three-Electrode Thermionic Valve as an Alternating Current Generator," by Prof. C. L. Fortescue.

"The Thermionic Valve as a Trigger Relay," and "The Use of Thermionic Valves in Parallel," by W. H. Eccles, D.Sc., and F. Jordan, B.Sc.

In addition to these there was an important discussion on the use of Valves, opened by Dr. Eccles.

In addition to the above the report of the Committee on Radiotelegraphic Investigations was presented to the meeting. In this report it was pointed out that owing to the continuance of wartime restrictions on wireless working, only a few statistical records were obtained, and from Colonial Stations only. The arrangements made by the Committee for Radio-investigations during the Solar Eclipse of May 29th were also dealt with, and the chief features discussed.

Aircraft Wireless Section

Edited by J. J. Honan (late Lieutenant and Instructor, R.A.F.).

These articles are intended primarily to offer, as simply as possible, some useful information to those to whom wireless sets are but auxiliary "gadgets" in a wider sphere of activity. It is hoped, however, that they may also prove of interest to the wireless worker generally, as illustrating types of instruments that have been specially evolved to meet the specific needs of the Aviator.

AIRCRAFT WIRELESS SETS.

SPARK TRANSMITTERS.

IN addition to the No. 1 Transmitter, a considerable number of other spark sets suitable for use on or in conjunction with aircraft were evolved during the war by the R.N.A.S., R.F.C., and R.A.F. They mostly belong to the earlier period. In the later stages the great superiority of the valve as a generator, particularly for light-powered sets, together with the general advantages of continuous-wave transmission, led to its adoption in practically all the most modern aircraft installations. These will be dealt with in later issues.

Meanwhile a short description of one or two other Service spark sets may be of interest.

THE 55A.

This is a 2-kilowatt set and is one of the heaviest spark installations used for aircraft work. It was originally fitted to Hawker's machine, but unfortunately the alternator was burnt out during a preliminary test, and the set was still useless when the sudden decision to start was made.

A photograph of the set is given in Fig. 16, whilst the skeleton circuit diagram, Fig. 17, shows the open and

closed oscillatory circuits and the coupling inductances.

The exciter, alternator, and rotary gap are mounted upon the same shaft, and are driven through gearing from the propeller shaft of the bus.

The exciter is a shunt wound 0.2 kilowatt, giving a direct current of 4 amps. at 50 volts, whilst the alternator is the 2 kilowatt Mark III type giving 500 cycles at 180 volts on a speed of 3,750 revolutions per minute.

A closed-core, oil-cooled transformer is used, taking 180 volts through the primary and giving 10,000 volts across the secondary.

The sliding coupling-inductances A, B, shown separately at the foot of Fig. 17, are contained in boxes, placed one over the other, and together with the transformer and condenser C are housed on the same bed-plate that supports the alternator.

The wavelength is adjusted between 150-550 metres by plugging-in on the coil B, the coupling between the open and closed circuits being varied by sliding the upper coil B over the lower coil A. For longer wavelengths, series loading inductances are inserted in both circuits.

A search light was fitted in the prim-

AIRCRAFT WIRELESS SECTION.

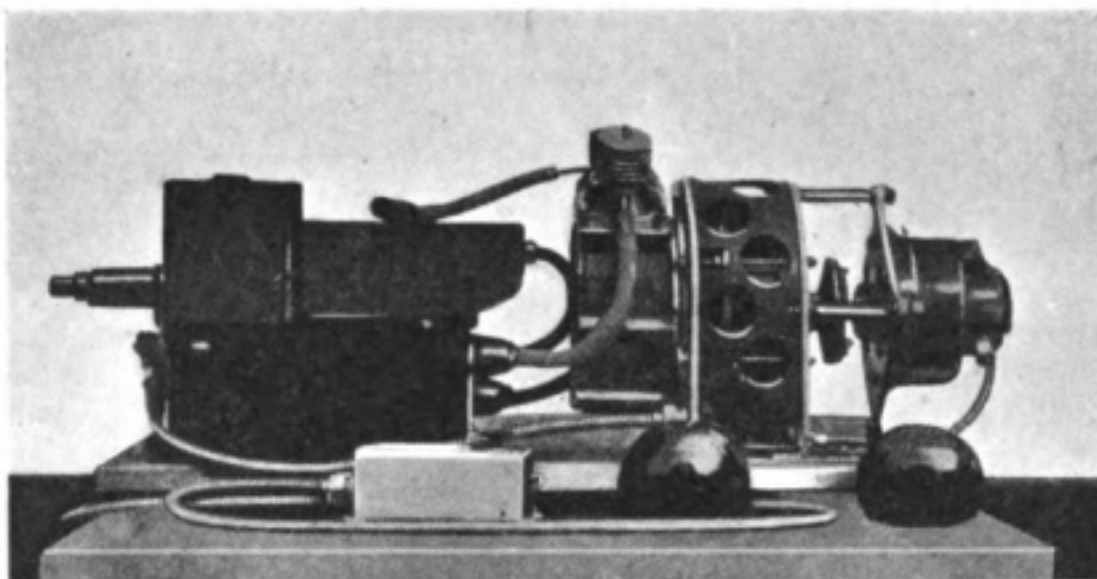

Fig. 16.

ary circuit of the set as used on active service.

Some of the chief points of interest in this set are set out under the following headings:—

ALTERNATOR.

The complete stator is mounted on Duraluminum supports bolted to the end plate.

The rotor has eight poles wound in

series and all in the same direction. The spider and pole pieces are all of mild steel, the latter being cast separately and bolted to the spider. Intermediate pole pieces are placed between each of the main poles, and are bridged by pieces of mild steel.

A leather driving-ring is bolted and soldered to the outer flange, and is also bolted to the driving spider on the exciter shaft, the whole forming a universal coupling.

The brush gear comprises two brushes set at 180° , an even pressure on the slip ring being secured by two light springs. The complete gear is mounted on a floating frame carried by loose links which must be reversed before running the machine anti-clockwise as otherwise they are liable to jam and be damaged. For this reason the rotor pulley should always be turned clockwise when making a preliminary test before starting up.

If it is desired to run on reverse, the field leads to the brushes on the exciter must of course be changed over.

SPARK GAP.

This is enclosed in an aluminium casing pierced at the front and sides, the apertures being covered with fine copper gauze in order to afford ventilation

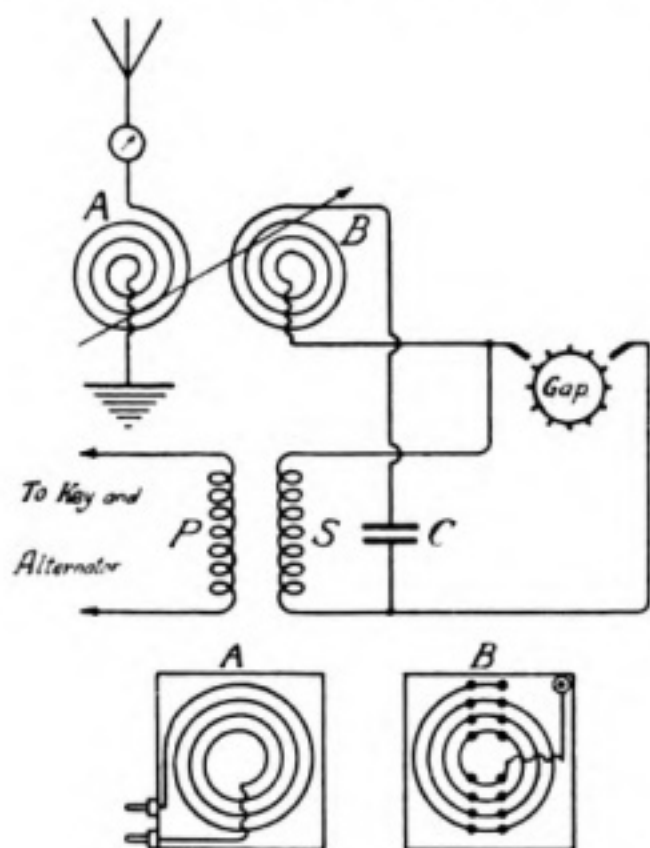

Fig. 17.

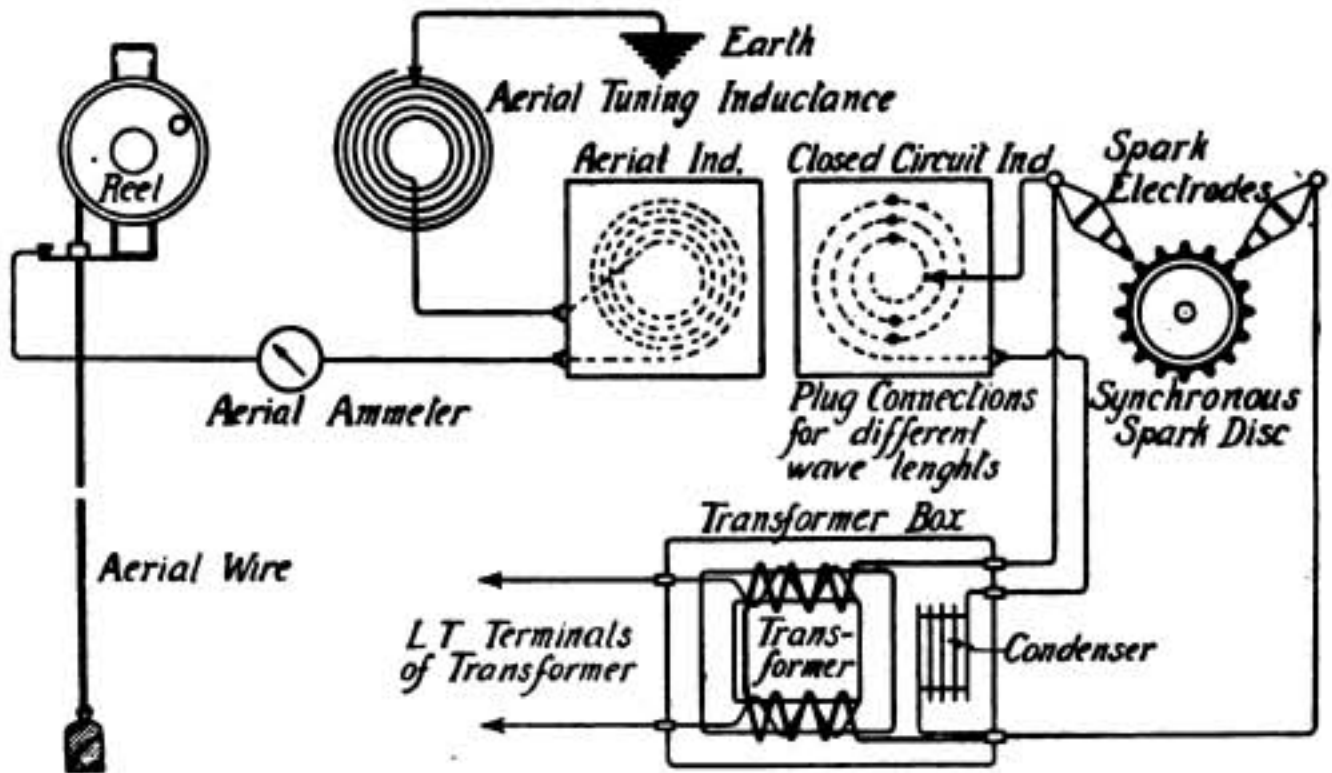

Fig. 18.

while minimizing the danger of fire in an atmosphere that may be highly charged with petrol—or, in the case of airships, that may comprise a highly inflammable admixture of gas.

The spark gap distance is adjusted by turning the outermost nut over the cooling-fins. The rotary disc has 16 spark points. As it is mounted on the same shaft as the 8-pole alternator synchronism is ensured.

Before starting up the arrows on the end plate of the alternator and spark box should be in register. If not, they must be aligned by turning the phase adjuster accordingly. A special key is provided for this purpose.

KEY BOX.

The key box is fitted with two switches. One closes the exciter circuit to energize the set, and the other controls the searchlight, which is inserted in the primary circuit from the

alternator. A direct-current ammeter is mounted over the box to indicate the current in the exciter circuit.

TRANSFORMER BOX.

This contains the closed-core transformer and the condenser. The side of the box is fitted with five oil-tight brushes through which the leads pass. The whole is filled with oil. The condenser is clamped to the inside of the box, the securing-bolts being filled with rubber washers where they pass through the sides of the box in order to prevent leakage of oil.

WEIGHT AND RANGE.

The total weight of the set is approximately 90lbs. Its range with maximum coupling and crystal reception is about 300 miles under normal conditions.

Fig. 18 is a schematic diagram of the windings, omitting the alternator and exciter.

(To be continued.)

AEROPLANE WIRELESS RECORD.

In connection with the recent transatlantic flight of the American seaplanes, it is interesting to note that a transmitting range of 1,800 miles from the aeroplane to the ground station has been claimed. This constitutes the longest distance officially transmitted from an aeroplane to the earth.

Aviation Notes

THE COMMERCIAL ASPECT.

THERE are many indications that, before long, aviation will be firmly established in the Commercial field as an active competitor with existing Transport Services.

A regular daily service for passengers and light goods has already been inaugurated between London and Paris by the Aircraft Transport and Travel Company controlled by Mr. Holt Thomas, with whom General Sir Sefton Branckner (late R.A.F.), is associated.

Mr. Holt Thomas intends to maintain this service throughout the winter, and hopes to secure a ninety per cent. efficiency. Only dense fog or ex-



Photo by Sport & General
GENERAL SIR SEFTON BRANCKNER.

ceptionally bad weather will be allowed to interfere with the daily flights.

The scheduled time for the journey is just over two hours, and the passenger fare is at present twenty guineas per head for the single trip, with a 10lb. allowance of personal luggage. Individual parcels can be sent at the rate of 7s. 6d. a lb., but regular deliveries over a stipulated period are accepted at half-rates. A widespread collection and delivery scheme is in operation in both capitals in connection with the parcel traffic.

The same Company also proposes to institute a regular Folkestone-Boulogne passenger service for those who prefer a fifteen-minute flit in the air to the joys of spending an hour and a half on the ocean waves.

In addition the Handley Page Transport Company are running a daily service from their Cricklewood aerodrome serving Paris and Brussels on alternate days.

The first regular air way in this



Photo by Topical Press
MR. HOLT THOMAS.



Latest type Handley-Page Machine as used for Commercial-flying.

country, the Stockport and Manchester-Blackpool route, was established some time ago by the Avro Company who claim to have transported over 20,000 passengers with a total casualty list of one minor accident. This Company advertises its willingness to carry individual passengers to Paris or anywhere else, but does not at present contemplate setting up a regular cross-channel service.

In its present stage of development the widest field of employment for the plane as an agent of general utility would appear to be offered by the Mail Service. The carriage of correspondence is, however, entirely under Government control and is, therefore, not a matter for individual commercial enterprise. But it is to be hoped that the Post Office will not long ignore a mode of transport that apparently affords a more expeditious means of communi-

cation between London and Paris than is to be secured at present by either the Telephone or Telegraph services.

To-day commercial aviation claims only the cream of the passenger traffic *de luxe* and occasional light parcels of urgent merchandise as its share of transport work. But existing difficulties and handicaps are being successfully tackled; initial cost, and upkeep and running expenses are being reduced;—in a word rapid strides of progress are being made. But a few years ago, the gas bag represented the only air-borne vehicle. A few years hence, and aviation may provide the means of forcing the Railway Companies, under the stress of competition, to drop that extra fifty per cent. on passenger fares!

• • •

AVIATION IN GERMANY.

Over there they still believe in the Zeppelin. At present a daily service

AVIATION NOTES.

is being run between Berlin and Friedrichshafen on Lake Constance, a distance of 380 miles. The craft used is a small type of Zeppelin specially constructed for the purpose. It is about 400 feet long, has a capacity of 20,000 cubic metres, and can carry from ten to twelve tons. This type has the advantage that it can easily be handled, especially when being taken out from, or returned to, the shed; and it carries only a small crew. Four motors, developing 1,100 horsepower give a normal speed of 70 miles per hour.

The passenger cabin contains 20 easy chairs ranged 10 on each side, and can accommodate altogether 25 passengers. It is fitted with Wireless Telegraph apparatus, a lavatory with running water and a canteen where hot and cold food can be obtained. Altogether it seems to be able to give the average seaside boarding house points in general comfort and convenience. The fare is 400 marks (nominally £20) for the single journey and 30lbs. of personal luggage are carried free for each passenger.

BRITISH AIRCRAFT COMPETITION.

The Air Ministry announces that the Government has decided to offer prizes to the value of £64,000 in a competition open to the British Empire for the best submitted designs of (a) Aeroplanes, and (b) Seaplanes.

The aeroplane section is divided into two types, viz.: (1) small type with a total carrying capacity of two persons (including the pilot) and (2) large type with seating accommodation for 15 persons (exclusive of crew). The prizes offered for the smaller type are, 1st prize, £10,000; 2nd, £4,000; 3rd, £2,000. The Government also contracts if the competitor is willing, to buy the machine winning the first prize

for £4,000, the designs remaining the property of the entrant. In the larger type the prizes offered are: 1st, £20,000; 2nd, £8,000, and 3rd, £4,000. The Government offers to buy the first-prize machine for £10,000 under the same conditions.

In the case of seaplanes the carrying capacity must be four persons, exclusive of the crew, and the prizes offered are £10,000, £4,000 and £2,000 with a purchase price of £8,000.

The competition opens on 1st March, 1920, and closes on December 31st of that year.

The principal object, as set out in the conditions, is to ascertain the type of craft that offers maximum safety in the air combined with the advantages of alighting in and rising from the minimum ground space.

The small type of plane must be capable of flying level with full load at or above 100 miles per hour and also at or below 40 m.p.h. For the larger type these speeds become 90 m.p.h. and 45 m.p.h. respectively. Climbing power, in the case of the smaller craft must be not less than 500 feet in the first minute from ground level, and 350 feet for the larger type.

GORDON SHEPHARD MEMO- RIAL PRIZES.

The father of the late Brig.-General G. S. Shephard, D.S.O., M.C., has placed, in memory of his son, a sum of money in trust, the income of which is to be applied to the provision of annual prizes for Essays on Airmanship open to Officers, N.C.O.s and men of the R.A.F.

The specified subjects this year are: (1) Sea and Fleet Reconnaissance, and (2) Aerial Navigation and Pilotage.

The administration of the prizes is being carried out by the Air Council.

WRECK OF THE "FELIXSTOWE FURY."

Probably the biggest air-craft in existence, the Porte flying boat—popularly known as the Felixstowe Fury—crashed at the very outset of a voyage that was planned to include the entire traverse of the African Continent from Alexandria, via, Khartoum, Tanganyika, Beira and Durban, to Cape Town. She had barely left the slips at Felixstowe harbour, and had risen only 10 or 15 feet, when the left wing dropped and caught the water. The vessel swerved round and almost simultaneously nose-dived into the sea.

She carried a crew of seven, all of whom were rescued with the exception of Lieutenant S. E. S. Macleod, the Wireless Officer, who unfortunately became entangled in the wreckage and was drowned before he could be extricated.

His name is yet another to be added to the list of gallant men of the wireless profession, who, in Peace as well as War, have made the supreme sacrifice in the interests of their calling and the demands of duty.

The boat was built under the supervision of Colonel Porte, and was of the triplane type. The span of the top planes measured 123 feet, length from nose to tail 60 feet, and height 27½ feet. She weighed 10 tons and could carry 30 passengers. Her set of five Rolls Royce engines were capable of developing 1,800 horsepower—sufficient to give her a speed of from 80 to 90 miles per hour under full load.

It had been intended to try her capabilities on the transatlantic flight, but her immense size rendered the question of transport on the outward journey to Newfoundland so difficult that the project was abandoned.

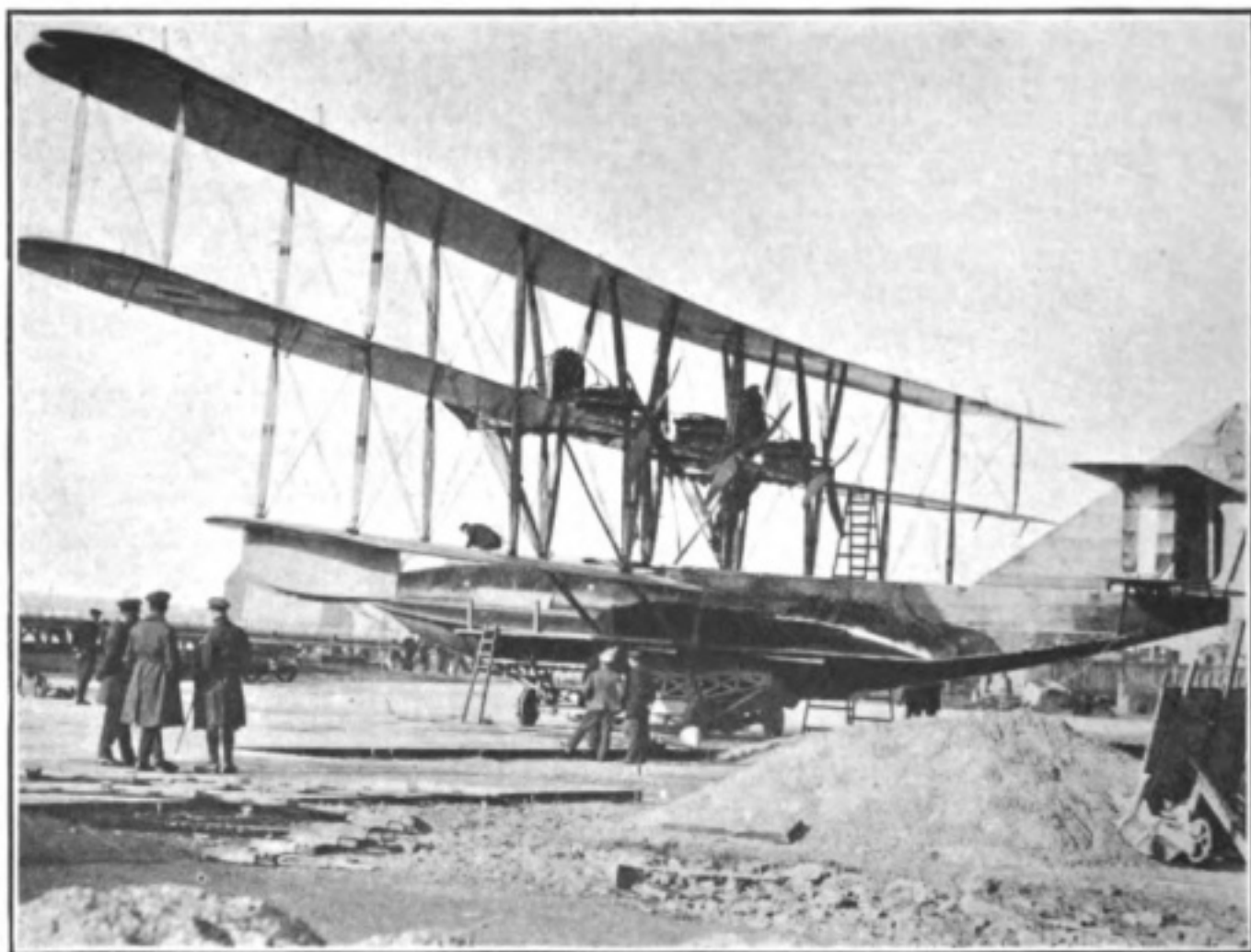

Photo by

The "Felixstowe Fury."

Associated Illustration Agencies Ltd.

AVIATION NOTES.

OFFICIAL DEMONSTRATION FLIGHT TO SCANDINAVIA.

With the specific object of demonstrating the advanced state of development of British aircraft, and the potentialities of flying boats for commercial purposes, an official tour of the Scandinavian countries organised by the Air Ministry has just been brought to a successful conclusion.

Flying boat, N.4044, was chosen for the trip, this type being considered most suited to the countries concerned. Very few land aerodromes exist in Norway, Sweden or Denmark, whereas sheltered stretches of water, forming natural "seaplane harbours" are to be found practically everywhere. There is undoubtedly a big commercial future for the right type of aircraft in these countries.

The development in Sweden and Norway in particular has, up to the present, been greatly hampered by the lack of sufficient transport facilities, owing to the distinctive geographical features of the Peninsula. The extended use of aircraft, on a commercially sound basis offers a promising solution to this difficulty. The point has not been overlooked by the Germans, who with characteristic acumen are already in the market, and offer both seaplanes and aeroplanes at unmistakably "cut" prices.

The N.4044 made an extended tour, visiting Christiania, Copenhagen, Stockholm and several intermediate towns. A total distance of 2,500 miles was covered in 40 hours of flying, in addition to numerous exhibition flights all without a single mishap.

During her stay at Christiania the boat came under distinguished patronage. Queen Maud of Norway made two trips in her and, on the second occasion, "took charge" for a short period.

The official report of the voyage lays

particular stress upon the trustworthiness and usefulness of the wireless installation, which maintained communication with Dundee throughout the entire period of flight across the North Sea.

• • •

R34 ATLANTIC AWARDS.

The following honours have been awarded in connection with the voyage of the R34 across the Atlantic and back in July last:—

To be Commander of the Order of the British Empire—Major George Herbert Scott, A.F.C., commander of R34 on the voyage.

Air Force Cross.—Col. (A.-Brig.-Genl.) E. M. Maitland, C.M.G., D.S.O.; Capt (A.-Major) Gilbert G. H. Cooke, D.S.O.; Lieut. Guy Harris, 2nd-Lieut. John D. Shotter.

Air Force Medal.—No. 206345, Flight-Sergt. W. R. Gent; No. 200965, Sergt.-Major H. W. R. Mayes, D.S.M.; No. 314353, Flight-Sergt. W. J. Robinson; No. 200079, Flight-Sergt. R. W. Ripley; No. 201741, Flight-Sergt. N.A. Scull; No. J./3349, Sergt. H. M. Watson, D.S.M.

• • •

DWINA RIVER EXPEDITION.

The conditions under which the R.A.F. seaplane flight lives on the Dwina River are somewhat novel, and their duties arduous both by day and through the semi-darkness of the Arctic night. Enemy vessels have been effectively bombed and machine-gunned; spotting for the guns of our river flotilla has been directed by wireless and photographic surveys regularly carried out. Doubtless, also, wireless has played an important part in locating the position of their moving home, which consists of a barge which moves up and down the river according to requirements.

The Library Table

THE PRINCIPLES OF RADIO-TELEGRAPHY.

By CYRIL M. JANSKY.

London: The Hill Publishing Co., Ltd. Pp. ix + 242. 179 illustrations. 10/- net.

HERE are eleven chapters in this book, but not until the fifth is reached does the reader come to the subject of wireless telegraphy. The first four chapters deal with magnetic and electro-static phenomena, electromagnetism and units of measurement, after which there are twelve pages about electromagnetic waves. We do not understand why the last-mentioned chapter is followed by a discussion of elementary alternating currents; surely the student should have a sound acquaintance with these phenomena before he attempts to grapple with the problems of aether waves. Some twenty-three pages are devoted to oscillatory circuits and a further twenty-eight to "radio circuits," a term which the author employs in order to indicate that he refers to oscillatory circuits capable of producing electromagnetic waves. The book concludes with three chapters on transmitting and receiving appliances and vacuum tubes.

In spite of certain defects to be mentioned later, the work under review is a useful addition to the ranks of books on wireless telegraphy intended especially for the beginner. The diagrams are very well drawn and the half-tone reproductions quite up to the average, with the exception of that illustrating on page 108 the oscillatory discharge of a condenser. Writing in general of half-tones, and in particular of those

which show the exteriors of the apparatus, we have long questioned their value in text-books of this nature. For example, in this book the British reader sees photos of apparatus made only by American firms and which he will in all probability never meet in practice.

True to what is promised in the preface the treatment is not mathematical beyond the standard of the average reader, and is rendered more luminous by a number of worked examples, aids which are so often lacking in otherwise excellent books.

There is evidence of hasty writing and hasty correction in this work and for the sake of future editions we must point out the following defects:—

(1) On pages 4 and 5 the blocks are evidently transposed and the explanatory text is not at all clear; for instance, on page 4 there is the statement that if the two magnets shown in Fig. 2 were allowed to swing freely in a horizontal direction, the two ends near each other would point in opposite directions. Yet the two ends are *like poles*. A great deal of the confusion of paragraphs 4 and 5 would be cleared up by putting the blocks in their right places.

(2) In the chapter on units the gramme is defined as the 1/1000 part of a mass of metal called the kilogramme. We know quite well what the writer has in mind, but we do not think his definition is a happy one. On page 39 there is a reference to an acceleration of "1 centimetre per second."

(3) On page 69 there occurs the surprising statement that by wavelength is meant the distance the wave advances in one second.

(4) On page 80 velocity is defined as

LIBRARY TABLE.

the time rate of motion in a specified direction; and the third property of velocity, *sense*, is ignored.

(5) On page 93 we read that if a condenser has one of its plates connected to both sides of a battery circuit, it will become charged. What is supposed to be done with all the other plates? In any case these should be metallic plates, though this is not made clear in the first line of the chapter on oscillatory circuits.

(6) On page 109 it is said that the discharge of a condenser is a process by which the potential energy of the charge is dissipated gradually in heat. Not always all of it, luckily for wireless telegraphy.

(7) In his definition of the antenna the author implies that the latter includes the A.T.I. the jigger secondary, a variable condenser and the earth system. Why not complete the list by including the hot-wire ammeter?

There are a number of misprints scattered throughout the book. It might also be remarked that the diagram on page 114 is not the best introduction to an oscillatory circuit that a student of wireless telegraphy could have, and that the practice of connecting the transformer across the transmitting condenser, as shown on page 160, is being abandoned. British readers will no doubt find rather confusing the use of the terms abvolts, abcoulombs, etc., and also the employment of the word Gilbert for magnetomotive force.

• • •

“THE THERMIONIC VALVE IN RADIO TELEGRAPHY AND TELEPHONY.”

By PROFESSOR J. A. FLEMING,
M.A., D.Sc., F.R.S.

London: THE WIRELESS PRESS,
Ltd. Pp. xv + 280, Price 15s. net.
It seems singularly fitting that Dr

Fleming, who took the first step in the utilization of Thermionic valves in Radio-telegraphy should also be the first British author to write an advanced comprehensive treatise on this all-important subject. Such a treatise will be welcomed for two reasons. In the first place, a large number of the original papers on this subject are only to be found in British and Foreign scientific papers, and are thus not conveniently accessible to many workers, and, secondly, the assimilation of all the salient results of these papers in a single volume will do much to standardize the nomenclature of the subject. The second reason is almost as important as the first for the tendency of radio workers to multiply new terms and names needlessly (a proclivity developed in America to the highest degree) can only produce a harmful confusion.

The first chapter contains an historical account of the subject of Thermionics and Electron Theory in general. A knowledge of the fundamentals of this subject is a *sine qua non* for all students of Radio-telegraphy who wish to understand thoroughly the action of a valve and its many applications. In reading this chapter one realizes how much we are indebted to workers in pure science (in particular to Sir J. J. Thomson and Prof. O. W. Richardson) for the large amount of information available about the ubiquitous electron. The second chapter deals solely with the Fleming valve and its applications, the subject being dealt with both from qualitative and quantitative standpoints. It is interesting to note that the first explanation of the action of the space charge is here attributed to C. D. Child and not to I. Langmuir as so many previous writers have done in error. The result of the famous Marconi and de Forest suit in

the United States Court of Appeals (which, of course, is now scientific history) is here given, while the full text of the pronouncements of Judge Mayer are given as an appendix to the book. The latter half of this chapter is devoted to the technique of the commercial methods of producing high vacua. Here we are reminded of one of the most flagrant cases of the needless multiplication of names. The "Kenotron" of Dr. Dushman is nothing more than a high vacuum Fleming valve. That Fleming nearly fifteen years ago recognised that a valve of extreme exhaustion would be a perfect rectifier is clearly shown by his remarks (not quoted in the book, however,) to the Royal Society in 1905 when he said, "An ideal and perfect rectifier for electrical oscillations may therefore be found by enclosing a hot filament and a cold metal anode in a very perfect vacuum."

The next two chapters are devoted to the Three-Electrode Valve as a detector and generator respectively. The original and suggestive work of E. H. Armstrong is fully described, and an interesting application of Maxwell's cyclic method of solving electrical problems is given, treating a valve and its circuits as an electrical network. The first discovery of the generating properties of the three-electrode valve is attributed to Meissner, though it appears to have been independently discovered later by Armstrong and also by Franklin and Round.

The last two chapters deal with the numerous applications of Thermionic valves in Radiotelegraphy and Telephony and include a thorough discussion of almost all ordinary circuits. One notable omission appears to be that no mention is made of the very common use of an alternating source of high potential, with hard Fleming valve rectifiers, for the plate voltage

of transmitting valves. The simple mathematical theory of the three-electrode valve is fully worked out, the results of Vallauri and Van der Bijl being summarised. It is on similar quantitative lines that the progress of valve design will be made.

This volume can confidently be recommended to the general physicist (who is indebted to the special subject of wireless for the development of such an invaluable laboratory instrument) as well as to radio workers, as a concise and lucid digest of the subject up to the present.

E. V. APPLETON.

USEFUL NOTES ON WIRELESS TELEGRAPHY.

By H. E. PENROSE.

London: THE WIRELESS PRESS, Ltd.

Books I.—V., 1s. 4d. each net.

Book I.—Direct Current, pp. 65.

Book II.—Alternating Current, pp. 50.

Book III.—High Frequency Current and Wave Production, pp. 66.

Book IV.—The Marconi $1\frac{1}{2}$ kw. Ship Set, pp. 77.

Book V.—The Oscillation Valve, pp. 53.

These booklets have been written with the object of presenting to students a brief resumé outlining the general principles underlying the transmission and reception of wireless signals. Their purpose is to act as guides to indicate the ground to be covered in other standard wireless text books in order to obtain a working knowledge of modern wireless apparatus.

Throughout the text a number of references are given to electrical and wireless text books, where more complete information on the details or apparatus under consideration can be obtained.

LIBRARY TABLE.

The first booklet of the series commences with an elementary consideration of the electric circuit, and then leads up to a consideration of accumulators, direct current generators and motors.

In the second, the ideas of varying and alternating current are introduced, together with the effects of condensers, inductances and of resonance. The alternator, Rotary - Converter and Transformer are also dealt with.

The third booklet brings in matter of a more particularly wireless nature with the consideration of H.F. currents and of types of waves, leading to a description of simple transmitting and receiving systems.

The fourth book deals entirely with particulars of the Marconi Ship Sets, with operating arrangements, and in particular concludes with an important chapter on fault tracing.

The fifth booklet is of rather a different class. It treats of the oscillation valve, commencing with the conduction of electricity through gases and a description of the Fleming rectifying valve. From this the ideas of the 3-electrode valve are introduced and various circuit arrangements described, including several arrangements of multi-valve amplifiers and means for the reception of continuous wave signals. This last booklet should be of special use to all students desiring a closer acquaintance with the use of valve receivers.

• • •

ELEMENTS OF THE ELECTRO-MAGNETIC THEORY OF LIGHT.

By L. SILBERSTEIN, PH.D.
Longmans, Green and Co., 3/6 net.
(Pp. 48.)

This little book has been re-written from the author's larger (Polish) treatise

on Electricity and Magnetism. The contents in particular cover the ground of Ch. 8 Vol. 2 of that work with slight additions and modifications. The author traces the development of the electromagnetic theory from the original proposals of Clerk Maxwell in 1865, and quotes the various reasons that have led to its general acceptance. Before considering the vectorial equations of the theory in detail a summary is given of the "elastic" theories of light and of the difficulties that were experienced in endeavouring to fit these in with well-known experimental facts. These difficulties increased as the earlier theories became more fully developed, and are quoted in the book to show up the superiority of the electromagnetic theory in explaining such phenomena. The classical experiments of Hertz served in their turn but to strengthen the development of this theory.

As the fundamental theory of all wave-propagation through the aether, a proper understanding of at least its leading features is of the utmost importance to all workers in the radio field. To them, therefore, and to all students of this subject, this little booklet should make a powerful appeal, as it puts forward the chief points and equations in a handy form, thus dispensing with the necessity of abstracting the desired information from a large mass of abstruse mathematical reasoning amongst which it is customarily buried.

After the initial exposition the author concludes the book by discussing the general formulæ and theories relating to the optics of crystalline media, and of the velocities of wave-propagation along the various axes of crystals.

A number of references are given to original publications, dealing with the development of the various theorems, which should be of use to workers in this field.

Personal Notes

U.S. WIRELESS MEN WIN DECORATIONS.

MAJOR - GENERAL GEORGE O. SQUIER, the well-known U.S. Army Wireless Expert, has been decorated with the Order of Knight Commander of St. Michael and St. George. The ceremony was performed by Earl Haig.

Mr. C. F. Elwell, Consulting Radio Engineer, has been awarded the Cross of the Crown of Italy. Mr. Elwell erected a Wireless Station at Rome.

NEW CHIEF ENGINEER AT G. P. O.

Mr. W. Noble, late Assistant Engineer-in-Chief of the London District for the Post Office, has been appointed to succeed Sir W. Slingo as Engineer-in-Chief at the G.P.O. Mr. Noble entered the G.P.O. in 1877 and served as Telegraphist in the Aberdeen Post Office; thus he has worked his way up to the present position from the bottom of the ladder.

SOME DANCE!

Old students of the Atlantic Wireless College, Cahirciveen, will be interested to hear that the annual dance was held in the Carnegie Hall on Tuesday night, August 26th. Dancing commenced 10.30 p.m. and lasted until 7 a.m. Over 200 guests were present, and a very successful evening was passed, due largely to the efforts of Mr. M. F. Flattey, the Secretary of the Committee.

LADY WIRELESS OPERATOR AND HER SHIP.



MISS M. ALSEN,
Wireless Operator on S.S. Jupiter for several voyages.



S.S. JUPITER.

DEATH OF LIEUT. McLEOD.



Photo by *LIEUT. S. E. S. McLEOD.* G. Vardyke, Ltd.

We much regret to record the death of Lieut. S. E. S. McLeod, late Wireless Officer of the "Felixstowe Fury," the famous Porte flying boat, which met with disaster just after starting for the Cape *via* Egypt on August 11th. Lieut. McLeod, being fastened in his seat, was unable to extricate himself from the wreckage and was drowned.

Correspondence

AN OPERATOR IN MESOPOTAMIA.

SIR,

Whilst working in Mesopotamia last October, I had rather an interesting experience with jamming.

We had two stations within six hundred yards of each other. D was equipped with a J-K.W. Marconi pack set and had an inverted L aerial with a directional effect towards the N.E. U was an umbrella aerial used for listening in only. About 3 miles S.E. of D there was another station having no connection with our work. We worked on 300 metres at D and this other station worked on 600 metres. Before U was erected we worked D and had no complaints from this other station about interference, we were sharply tuned and you will observe our directional effect N.E. would be such as to cause minimum interference with this station to the S.E. Yet directly U was erected complaints of jamming came in at once. After a time I was forced to the conclusion that D station caused forced oscillations in U and this aerial being an umbrella acted as an auxiliary transmitter with, of course, all round directional effect. In any case, on our lowering U aerial during transmission from D, we received no further complaints. One could actually get loud signals by merely connecting one end of the phones straight to U aerial and holding the other end, there being absolutely no connection with any instruments. Signals were best with a moderate pressure between finger and thumb, the rectifying effect is evidently here.

Yours truly,
C. R.

SIR,

I was interested to see in your April number reference to the charging up of aerials on board ship. I have had similar experiences in land work while in Mesopotamia, which might possibly interest you. On one occasion I was listening in on an 80-foot umbrella aerial near Hit in the Euphrates. There was no wind and no sign of a thunderstorm anywhere, whilst atmospherics were moderate. Quite suddenly, the aerial started charging up at a very rapid rate with the usual "sizzling" sounds of many brush discharges. I barely had time to short the aerial and remove my 'phones before a most violent rainstorm started, still without any thunder or wind. It lasted perhaps for five minutes, but it was the most intense rain I have ever witnessed, one could not see more than a few yards away. Unfortunately, I was too busy trying to save the apparatus to make further observations, but should probably have found, as in similar cases, the charging up of the

aerial ceased as the rain started. I venture to think there is food for thought in this connection. This phenomenon is common when a thunderstorm is near-by, but seems strange when there is no sign of a storm before or after.

Needless to say, dust storms are the bugbears of operators. A bad storm will charge up an aerial to such an extent that the frequency of discharge from aerial direct to earth across a $\frac{1}{2}$ -inch gap has been sufficient to cause a musical note. It is interesting to hear this note vary with the strength of the storm.

From about October to March in Mesopotamia the winds are nearly always North or South. With the former are associated fine weather and few strays, but directly the wind gets to the South again, the atmospherics start, with bad weather. Incidentally, the wind was south round about Armistice Day, but we were able to pick up tantalising scraps from Europe!

I am, etc.,
C. H. E. R.

SIR,

The treatment of amateurs in trouble at the Courts since August, 1914, seems most unfair when looked at from the point of view of the *bona-fide* amateur, whose very sureness of his own harmless intents, made him in many cases somewhat careless of secrecy and contemptuous of possible consequences, vaguely rebellious in his heart against the petty restrictions of "red tape" which forbade him that relaxation of mind that meant so much to him, for even after a long day of war work the old hobby would still have been a welcome diversion of interest.

The feeling of the amateur was only intensified when he realized how inadequate the restrictions were to stop anyone who wanted, from receiving from most of the stations in the British Isles. An indoor aerial within reasonable distance of any station would give good results, quite enough for its purpose, with practically no danger of discovery.

Thus the amateur whose only desire was to increase his knowledge, was fined and imprisoned for daring to think of such a thing, while the path of the other sort of person was ridiculously easy.

It is hoped that the influence of some of our great scientists and others of note in the wireless world will avail to assist the Government to grant the amateur the facilities for work and study, for which his war service has in no small measure merited him.

With best wishes for the success of your excellent magazine,

Yours truly,
REG. G. H. COLE.

The Construction of Amateur Wireless Apparatus

This series of Articles, the first of which was published in our April number, is designed to give practical instruction in the manufacture of amateur installations and apparatus. In the following article the author deals with the important question of THREE-ELECTRODE VALVE RECEIVING CIRCUITS. The Wireless Press Ltd., has arranged with Marconi's Wireless Telegraph Co., to supply complete apparatus to the designs here given, as soon as Amateur restrictions are released.

Article Seven—THREE-ELECTRODE VALVE RECEIVING CIRCUITS.

IN the last article we indicated broadly to the amateur the various types of circuit which are suitable for use in conjunction with a crystal detector. A crystal can only be used for one purpose, to rectify the oscillatory currents produced in the receiving circuits by the incoming signal in order that they may be rendered audible by the telephone receiver. In the case of a valve, however, there are four perfectly distinct ways in which the device may be applied in a practical receiving circuit, namely (a) as a high frequency magnifier; (b) as a rectifier; (c) as a note magnifier; (d) as a self-heterodyne for continuous wave reception.

(a) The Valve as a High Frequency Magnifier.

In this case the function of the valve is simply to increase the amplitude of the oscillatory currents induced in the receiving circuits in order that the rectifying device may operate to the best advantage. All rectifiers known at present, which are capable of working at radio frequencies, have a more or less rounded bend at the bottom of the characteristic curve. The presence of this bend renders the rectifier much less

efficient for currents of small amplitudes than for those which cause the device to operate on the steep part of the curve. The result of this effect is to cause a signal to be inaudible, although there may be sufficient energy in the signal to be heard in the telephones. This point is treated at some length in "The Elementary Principles of Wireless Telegraphy," and we would particularly draw the amateur's attention to it.

In Fig. 1 we have indicated in the simplest possible manner the arrangement of a valve for magnifying high frequency currents. In this Figure

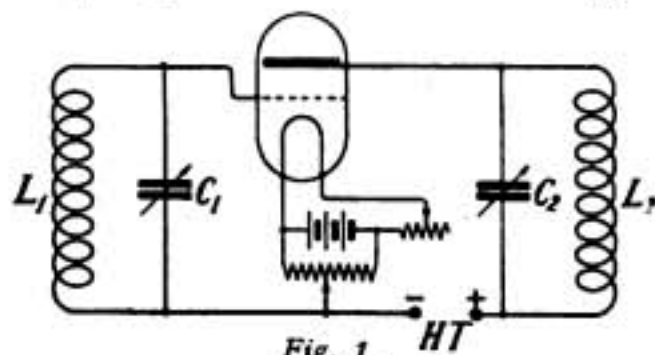

Fig. 1. HT

$L_1 C_1$ is an oscillatory circuit made up of an inductance and variable condenser of suitable dimensions to tune to the desired wave length. The grid and filament of the valve are connected respectively to the terminals of the condenser C_1 , the potentiometer being provided in

order that the grid voltage may be adjusted so that the valve is working at the best point on its characteristic curve. A similar circuit L_2C_2 is connected in the plate-filament circuit of the valve, a source of high voltage E.M.F. being included in the position indicated. The circuit L_2C_2 has such values of inductance and capacity as to tune to the same wave length as L_1C_1 . Any oscillatory current which may be induced from the receiving aerial or other source will cause high frequency alternations of potential across the condenser C_1 , it is clear from the diagram that this fluctuation of P.D. is directly applied between the grid and filament of the three-electrode valve. The effect of these potential variations is to cause changes in the direct current flowing from the high voltage source in the plate-filament circuit of the valve. This fluctuating direct current, since it is varying at a frequency corresponding to the natural time period of the circuit L_1C_1 rapidly builds up a comparatively large oscillatory current in the circuit L_2C_2 . Thus it is clear that in the arrangement shown we have a weak oscillatory current flowing in the circuit L_1C_1 magnified by the valve and resulting a similar current but of greater amplitude in the circuit L_2C_2 . This magnified current can readily be recti-

fied in the usual manner, and thus made to affect the telephone receiver.

Fig. 2 illustrates a practical receiving circuit utilising the principle just mentioned. The circuit consists of an aerial tuned by means of a variable condenser and inductance if necessary to the wave length to be received. This aerial is coupled by means of the jigger primary to a grid circuit of suitable proportions. The inductance of the valve-plate circuit has connected across it a crystal, potentiometer and telephone transformer. The incoming signals will produce a current in the aerial which in its turn induces a current in the valve-grid circuit. The magnified oscillations in the plate circuit are rectified by the crystal and rendered audible by the telephones as described in the last article.

With regard to the design of the various circuits. The aerial and its tuning arrangements have been fully described in connection with crystal receivers, and the principles there laid down should be adhered to. Since the valve is a potential operated device the ratio of inductance to capacity in the grid circuit should be as large as possible. As far as the valve circuits are concerned there is no necessity for the plate circuit to have a large L/C value, but since the crystal rectifier is

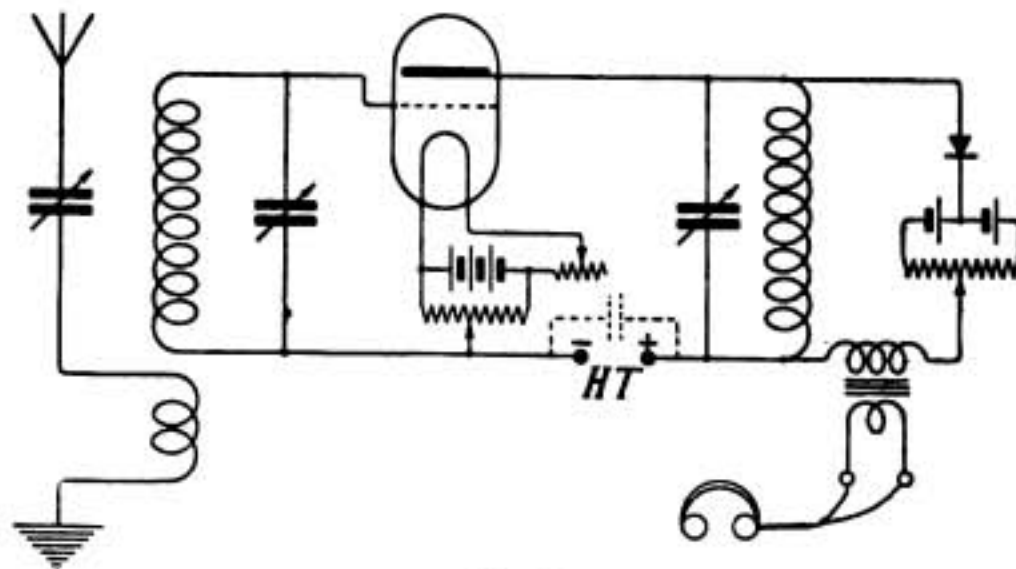

Fig. 2.

CONSTRUCTION OF AMATEUR WIRELESS.

connected across the plate inductance this circuit should also consist of a large inductance shunted by a small condenser. The amateur will do well to bear in mind the rule formulated in Article Six to the effect that the condenser of any oscillatory circuit used in connection with a potential operated device should not exceed .0003 microfarads in capacity, the inductances being of such values as are required to tune to the received wave.

A study of Fig. 2 will at once reveal the desirability of employing a telephone transformer in preference to high resistance telephones in the crystal circuit. The secondary of the transformer is directly connected to the positive pole of the high voltage source and since the negative end is earthed either partially or completely through the filament batteries, the insulation between the windings of the transformer is necessary to protect the operator from unpleasant shocks. It should be noted that the apparatus comprising the circuit should be connected up exactly as shown in the figure; any other arrangement may lead to loss of efficiency. For example, if the telephone transformer were connected at the top end of the plate circuit instead of as shown its capacity to earth would result in a reduction of the potential applied to the rectifier with a corresponding decrease in the strength of signals. It is also desirable to connect a condenser directly across the terminals of the high voltage supply. This condenser is shown dotted in Fig. 2. Its function is to act as a reservoir condenser in order that the plate current may accurately follow the variations in resistance of the valve. It is particularly necessary when dry cells are employed for the high voltage battery; when the cells have been in use for some time the internal resistance rapidly increases and consequently the

battery presents a considerable impedance to the high frequency currents. Also should a high voltage machine be used it will possess considerable inductance and may act as a complete break in the plate circuit to currents of radio frequency. In both these cases the condenser is obviously necessary, and the amateur should make a practice of including the condenser in his circuits as a matter of course.

(b) *The Valve as a Rectifier.*

In Fig. 3 is shown the arrangement of a circuit using a three-electrode valve as a rectifier or simple detector. The

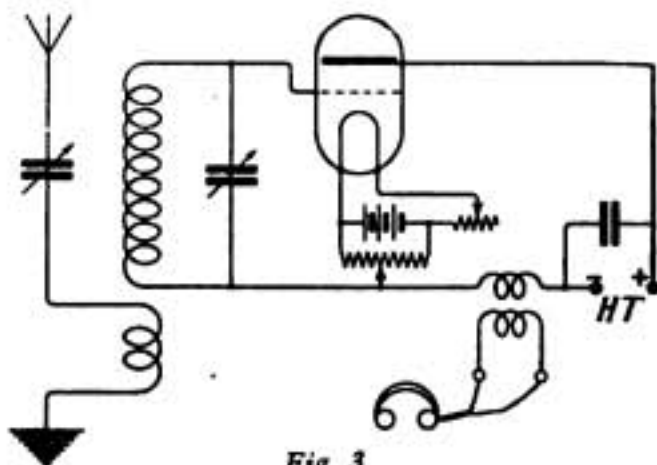

Fig. 3.

circuit is exactly the same in principle as that indicated in Fig. 4 of the last article. Again, the secondary circuit should have a large ratio of inductance to capacity, and the top end should be kept free in order that maximum potential may be applied to the grid of the valve. It should be borne in mind that when using the rectifying property of a three-electrode valve the potential of the grid is adjusted to such a value that we are working at the bend of the plate current characteristic curve. This bend is not very much sharper than that of a good carborundum crystal, consequently the sensitiveness of the arrangement is not materially greater.

(c) *The Valve as a Note Magnifier.*

The application of a valve to the amplification of the telephone current

which is of note frequency is very similar in principle to the high frequency magnification described under (a) the difference lying in the fact that since we are dealing with currents of comparatively low frequency iron cored transformers of large inductance are employed instead of the tuned oscillatory circuits. A typical note magnifier circuit is shown in Fig. 4. The

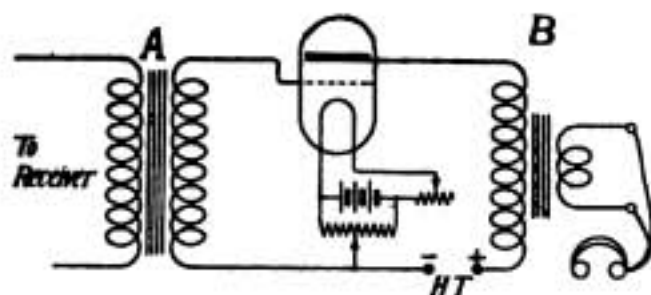

Fig. 4.

design of the grid transformer A will depend upon the exact conditions under which it is to be used. In any case the secondary (i.e., grid) winding will consist of a large number of turns of fine wire. The total number of turns it is possible to put on is limited by the fact that signals are muffled if this winding is made too long, as we cannot increase the inductance indefinitely without increasing the self capacity at the same time, and a point is eventually reached when the natural period of the windings is longer than that of the note to be amplified. The length of winding which may be used is found by experiment, and we shall give the amateur exact details when full designs are published. The primary winding should be adjusted to suit the manner in which it is connected to the

receiver circuits. If directly in series with the crystal it should have about the same inductance as the high resistance winding of a telephone transformer; if connected in place of the low resistance telephone used in conjunction with the receiver it should have about the same inductance as the low resistance winding of a telephone transformer. The plate transformer may very well be an ordinary telephone transformer. Should the circuit show an inclination to sing the fault can generally be remedied by connecting one side of the telephone winding to some point on the valve filament battery. All contacts in a note magnifier circuit must be good. A partial break will at once show up as an intermittent crackling or sizzling noise in the telephones which may drown out even the strongest signals. If trouble is experienced in getting the magnifier quiet it should be placed on a soft felt pad in order to insulate it from mechanical vibrations.

The successful working of valve circuits is largely a matter of experience and only practice will enable the experimenter to diagnose and correct the many faults which are liable to occur in home-made apparatus. A thorough understanding of the principles of the action of the valve is essential, and the amateur should make certain that he has a complete grasp of its action before taking up the practical side.

In the next article we shall deal with reaction circuits and the self-heterodyne for continuous waves.

SPECIAL NOTE.

Owing to the continued delay by the Government in deciding the lines upon which the wireless amateur will be allowed to work, we have been unable to execute our original plans of supplying detailed information for the manufacture of amateur wireless apparatus. Pending an announcement of policy by the authorities our contributor will continue the present series along the lines already laid down.

Patent Section

124,499. Wireless Telegraphy. Clarke, E. R., 35, Leinster Gardens, Hyde Park, London. February 11th, 1916. No. 2066 (Class 40 (v).)

A wireless receiving arrangement for heterodyne working with undamped waves comprises a tuned aerial circuit coupled in one coil of an intermediate circuit having another coil coupled to a tuned secondary circuit, the intermediate circuit being without a condenser and containing the grid and filament of a three-electrode valve, and the inductance and capacity of the secondary circuit are in parallel in the high-tension circuit of the valve. As

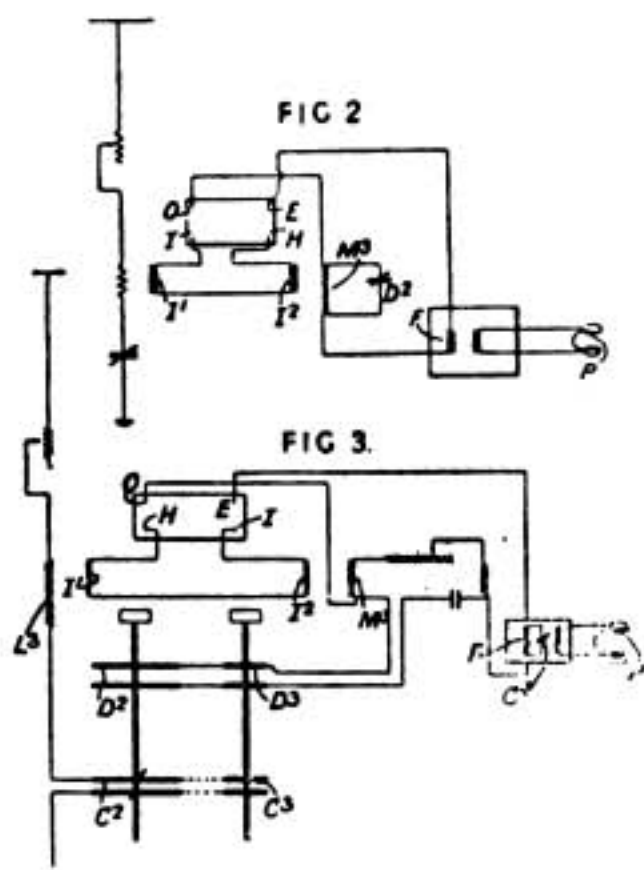

shown in Fig. 2, the aerial circuit is coupled to a coil I^1 in the intermediate circuit, which also includes a coupling-coil F^2 , the valve grid connected to terminal I , and the filament connected through a potentiometer to the terminal H . A secondary oscillating circuit comprising an inductance M^2 and capacity D^2 is coupled to the intermediate circuit at the coil I^2 , and is connected through a telephone transformer F to the terminals E , O of the valve. The terminal E is connected to the filament, and the terminal O is connected through a high-tension battery to the plate or outer electrode of the valve. The secondary of the transformer F is in circuit with a telephone P . Oscillations set up by the valve owing to its grid circuit and plate-circuit being inductively coupled at the coils I^2 , M^2 interfere with the

received oscillations and give an audible note in the telephone P . The couplings L^2 , I^1 and M^2 , I^2 are preferably of the rotary type so as to give a loose coupling on either side of zero. In another arrangement shown in Fig. 3, fixed inductances and capacities are placed in the secondary circuit equal to those in the aerial circuit, and variable condensers C^2 , D^2 are placed in the respective circuits and are adjusted jointly by rotating a common shaft so as to put the primary and secondary in tune with the incoming waves, as described in Specification 1402/15. Small variable condensers C^2 , D^2 arranged one in each circuit, are subsequently adjusted by a common shaft but in such a way that as one is increased the other is diminished, so that both circuits are put slightly and equally out of tune with the incoming waves. The heterodyne note selected is that most suitable for the telephone employed, and the primary of the telephone transformer F is shunted by a variable condenser C^4 and tuned to this note. The telephone current in the coil F may be amplified by an auxiliary three-electrode valve, and a condenser placed between the terminal H and the corresponding terminal of the auxiliary valve.

126,030. Wireless Signalling. Soc. Francaise Radio-Electrique, 10, Rue Auber, Paris. October 31st, 1916. No. 15547. Convention date, December 8th, 1915. (Classes 39 (i) and 40 (v).)

Discharge-gap apparatus for the production of electric oscillations consists of an evacuated vessel 1, containing a heated cathode 2, and an anode 4 of mercury. Instead of mercury, an amalgam of a metal capable of emitting vapour may be employed. The amalgam may be distributed over the interior of the vessel; and the cathode may be convex instead of parallel to the surface of the mercury.

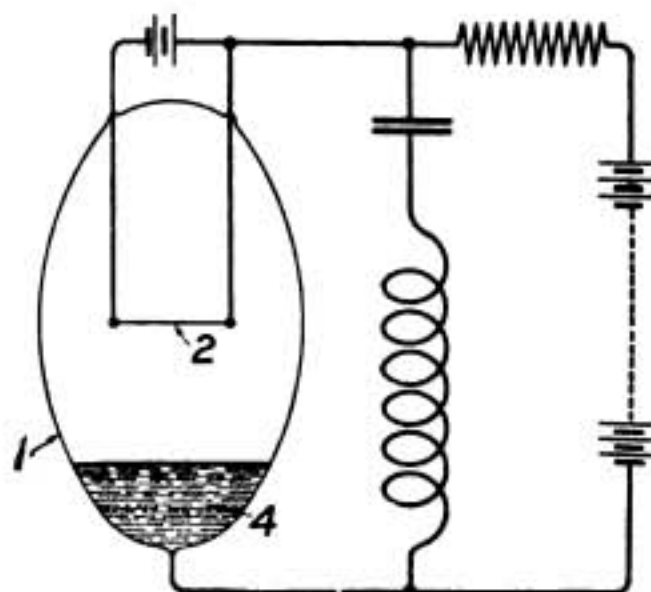

124,506. Wireless Signalling. Artom, A., 18, C. Siocardi, Turin, Italy. February 17th, 1916. No. 2402 (Class 40 (v).)

Directive propagation and reception is effected by connecting a number of co-planar aerials to condensers arranged in series or in parallel, or to intermediate points of an induction coil. Fig. 1 shows one arrangement with groups of condensers c^1, c^2 , etc., in series in the generating-circuit and with the aerials a^1, a^2 , etc., connected to the end plates of each group. The aerials may be placed symmetrically as shown, or unsymmetrically. In Fig. 8 the condensers c^1, c^2 , etc., are shown in parallel in the generating-circuit, and the aerials a^1, a^2 , etc., connected in pairs across the condensers. Loop aerials may be used instead of the open aerials shown. Figs. 6 and 7 show modifications in which inductance coils are substituted for the condenser battery. Fig. 9 shows a switch mechanism for varying the connections of the generating or reception circuit to the aerials. The condenser plates are arranged radially and are connected to contact bars d over which insulating switch arms i^1, i^2 may be adjusted separately by a knob n . Leads from the generating or reception circuit are connected to terminals x, y on the ends of the switch arms. The aerials a^1, a^2 , etc., are coupled to terminals e which lead to intermediate points on the ring of condenser plates.

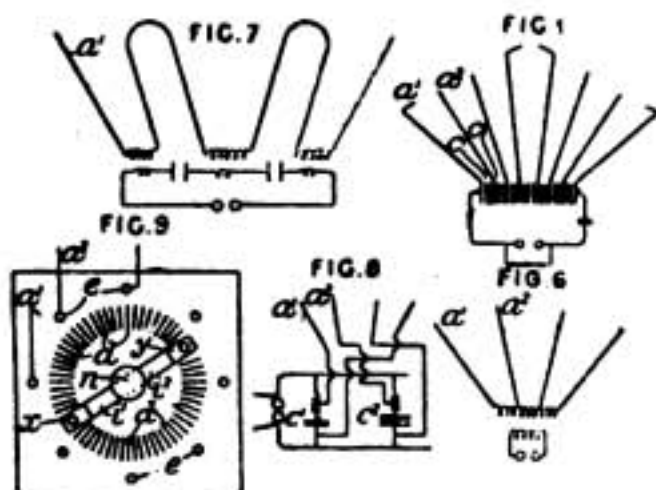

All the aerials may be tuned to one wavelength, or multiplex reception may be effected by tuning different aerials to the various wavelengths used. The currents in the various aerials may differ in strength and phase.

124,721. Vacuum Tubes. Connecticut Telephone and Electric Co., Meriden, Connecticut, U.S.A. (Assignees of Doule, H.P.; Meriden, Connecticut, U.S.A.) February 28th, 1919. No. 5047. Convention date, March 23rd, 1918. Not yet accepted. Abridged as open to inspection under Section 91 of the Act. (Class 39 (i).)

A valve for use in wireless telegraphy and telephony has a filament in an exhausted bulb and a grid and anode both mounted outside the bulb. As shown, the grid 6 and anode 5, which may both be of silver or copper, are

mounted outside a bulb, for instance by electro-deposition, the anode being larger than the grid. The adjoining edges are separated by an insulating space 7, and may be serrated

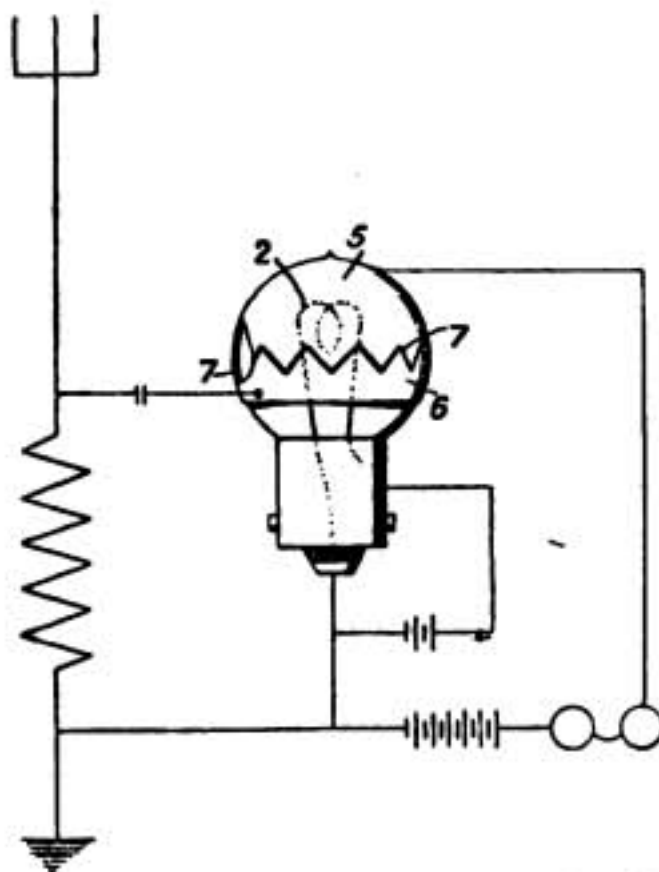

as shown, or straight. It is stated that the bulb, when heated, permits an electron flow from the filament 2 to the anode and thus enables the valve to act as a detector or amplifier, and also as a generator of sustained oscillations.

126,146. Producing High-Frequency Oscillations. Marconi's Wireless Telegraph Co. and Shoenberg I., Marconi House, Strand, London. May 6th, 1918. No. 7596. (Classes 35 and 40 (v).)

With a view to utilising the q th harmonic of a high-frequency dynamo-electric generator, the ratio of the breadth of the rotor teeth to their pitch is made equal to the fraction $\frac{1}{q}$ multiplied by an odd integer greater than 1.

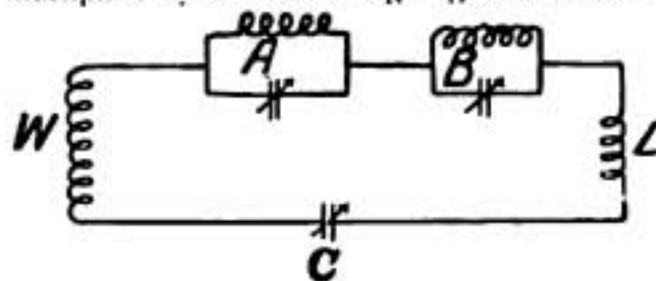

The induced winding W of the generator is connected through a capacity C and rejecting circuits A, B to an Inductance L , the circuit A being tuned to the frequency of the fundamental, and the circuit B to the frequency of the third harmonic, while the circuit $W A B L C$ is tuned to the frequency of the utilised fifth harmonic. Specification 101,148 is referred to.

Questions and Answers

NOTE.—This section of the magazine is placed at the disposal of all readers who wish to receive advice and information on matters pertaining to both the technical and non-technical sides of wireless telegraphy. Readers should comply with the following rules: (1) Questions should be numbered and written on one side of the paper only, and should not exceed four in number. (2) Queries should be clear and concise. (3) Before sending in their questions readers are advised to search recent numbers to see whether the same queries have not been dealt with before. (4) The Editor cannot undertake to reply to queries by post. (5) All queries must be accompanied by the full name and address of the sender, which is for reference, not for publication. Queries will be answered under the initials and town of the correspondent, or if so desired, under a "nom-de-plume." (6) Will readers please note that as amateurs they may not at present buy, construct or use apparatus for wireless telegraphy or telephony. (7) Readers desirous of knowing the conditions of service, etc., for wireless operators, will save time by writing direct to the various firms employing operators.

R.S. (Howden).—The Association of Wireless Telegraphists, 69, Hastings House, Norfolk Street, Strand, W.C.2.

R.H. (Dursley).—We regret we are unable to comply with your request. There are, however, exceedingly few firms which do what you mention.

NONPAREIL (Cambridge).—(1) Yes, if you are fully qualified. See Note 7 at the head of this column. (2) Not connected with the Mercantile Marine. You might try to secure a position on a shore wireless station.

D.H.G.M. (Glasgow).—Asks: (1) Why some stations are heard better on No. 1 crystal of Marconi's Type 31 receiver, and others are heard better on No. 2 crystal?

This is probably due to the amplitude of the incoming oscillations of some stations suiting the characteristic curve of No. 1 crystal while the amplitude of other waves suits the characteristic curve of the other crystal.

(2) Why do some signals increase in strength when the coupling is loosened, while others decrease?

The coupling depends on the mutual inductance of the two circuits. In a well designed receiver it is possible to increase signals through the maximum strength and then decrease them. Hence although the position of the coupling coil is brought back towards *O* the coupling may be increased up to a certain point and then decreased.

L.A.W. (Bradford).—A formula for the calculation of the inductance of a "pancake"

type A.T.I. is given in Fleming's Principles of Electric Wave Telegraphy, 2nd Edition, p. 139.

The inductance can, however, be approximately calculated as being equal to that of a cylindrical coil of the same number of turns, with a diameter equal to the mean diameter of the spiral, and axial length, equal to the width of the winding of the spiral, *i.e.*, $l = R_1 - R_2$, where R_1 , R_2 are the radii of the inner and outer turns.

(2) We certainly do not advise you to make an inductance on the lines you suggest, as it would not be nearly as efficient as one wound on a single former owing to the capacity between each winding and the others, and the distribution of potential over the coils.

The resultant inductance of inductances connected in series is the sum of the individual inductances. In your case, however, the calculation is made more involved by reason of the mutual inductance between each coil and the remainder.

H.S. (Bexley Heath).—(1) A difficult question, for the length of time necessary for you to qualify for the P.M.G.'s Certificate depends largely upon what knowledge you have before you begin to study and upon how much time you can give to study. If you attend a good school you might succeed in six or nine months. (2) Practically so. You would have to pass the Doctor.

T.S.B. (Clapham).—(1) White uniform suits are essential but mess suits optional. (2) How can we possibly say whether "all naval tailors" can supply a certain kind of cloth? (3) No. For instance, many of the trawler installations are being dismantled. (4) You can take it as a certainty that wireless telephony will not replace wireless telegraphy in the Mercantile Marine, but is intended to augment the means of communication at present provided aboard ships.

F.B. (Hartfield Cove).—Please refer to Note 7 at the head of this section. If you have served as an operator in the Navy you should not have much difficulty in obtaining your P.M.G. Certificate, which is essential.

E.A.W. (Clapham Road).—(1) Sorry we cannot. Anyhow, there are very few of them, mostly colliers. (2) You might get your P.M.G. Certificate in six months, but you will understand that it depends not so much on the Course as upon your own capability. In any case it means very hard study and practice. (3) Better write to the Traffic Manager, Marconi International Marine Communication Co., Ltd., Marconi House, Strand, W.C., for a copy of Conditions of Service. You will find a full answer to your question therein.

M.G.F. (Brighton).—All enquiries respecting facilities for wireless working should be addressed to the Secretary, G.P.O., London.

G.J.G. (New Cross).—You might apply to any of the Railway Companies who employ their own operators, but we do not think you will succeed in obtaining a shore position at once; the latter you might obtain by applying to Marconi's Wireless Telegraph Co., Marconi House, Strand, London, W.C.2.

V.H.A. (Tottenham Court Road).—Wireless Operators are trained in evening classes at the British School of Telegraphy, Clapham Road, and at the London Telegraph Training College, Earl's Court, London. Particulars of the fees can be obtained by direct enquiry. The length of training necessary depends largely upon the qualities of the student, but should not exceed nine months. The prospects of the profession can be ascertained by consideration of the conditions of service under the Company it is proposed to enter. Generally speaking, they are good.

T.H. (Birmingham).—To obtain a position as Wireless Operator in the Mercantile Marine it is essential to possess the Postmaster-General's Certificate of proficiency. On obtaining this, application should be made to the Marconi International Marine Communication Co., Ltd., Marconi House, Strand, London, W.C.2, which Company will give full particulars of the rates of pay, etc.

P.W.S. (Bletchley).—(1) No. (2) Yes, if supplemented by the training necessary to obtain the Postmaster-General's Certificate of proficiency. (3) In your case the necessary training would probably not exceed six months.

L.W.E. (East Sheen).—If you wish to become an apprentice in the Merchant Service write to the Assistant Secretary, Marine Dept., Board of Trade, Whitehall, S.W., for a list of Shipowners who take apprentices. We understand, however, that there are so many boys waiting to go to sea, that without influence you do not stand much chance of being accepted.

W.B. (Norfolk).—Asks: (1) Why the manipulating key is between the fuse and the transformer in the $\frac{1}{2}$ -K.W. Set, whereas in the $1\frac{1}{2}$ -K.W. Set the key is between the transformer and the L.F.I.C. †

The transformer key and L.F.I.C. in both sets are in series and are connected across the terminals of the board, and it makes no difference if the relative positions of these in the circuit are altered.

(2) What is the exact action of the earth-arrester gap?

The use of this piece of apparatus obviates the necessity of using a change over switch for sending and receiving.

The earth-arrester gap is connected in series with the aerial, and the receiving instruments are connected across the gap. When the aerial is being used for transmission the high voltage in the aerial breaks down the resistance of the gap and a spark occurs. The

resistance of the gap to the received oscillation is very great and as the received current cannot break down the resistance of the gap the current will flow round the receiving instruments to earth.

[With reference to the answer to the second question of "Query" (Gt. Yarmouth) in our last issue, part of this reply is unfortunately somewhat incorrect. The speed of the machine rises from its normal value whether the brushes are moved forwards or backwards from their normal running position. The test figures for a standard $1\frac{1}{2}$ -K.W. rotary converter are as follows:—

BRUSHES	SPEED	A.C. VOLTS
Neutral	1500 r.p.m.	81
Moved forward	1570 r.p.m.	84
Moved backward	1530 r.p.m.	82

It will be noted that the rise of voltage in each case is practically proportional to the rise in speed, indicating that the increased A.C. voltage arises simply from the higher speed of rotation of the armature in the normal strength field, and that the effect of the demagnetising component due to the armature windings on the A.C. voltage is quite small. The reason why the r.m.s. A.C. voltage (which is what is read on the voltmeter) rises over the usual value of $0.707 \times$ D.C. voltage, is to be found in the wave distortion that occurs when the brushes are moved, since the normal factor of 0.707 is true only for a sine curve. When the brushes are displaced the wave form becomes more rectangular in shape, with a consequent increase in the ratio of R.M.S. to peak value.—Ed., W.W.]

SHARE MARKET REPORT.

The market in the shares of the Marconi group has been very active during the past month. Large sales have been made on Italian account but all shares offered have been readily absorbed.

The shares of the American Company have appreciated considerably on the announcement from New York that all Wireless Companies will be amalgamated under one head in America and that considerable benefit will accrue to their Company in consequence.

Prices as we go to press (September 15th) are:—Marconi Ordinary, £5 12s. 6d.; Marconi Preference, £4 17s. 6d.; Marconi Marine, £3 3s. 9d.; American Marconi, £1 13s. 6d.; Canadian Marconi, 15s. 6d.; Spanish and General, 14s. 0d.

PATENTS, Inventions, Trade Marks.—Advice and handbook free.—King's Patent Agency, Ltd., 165, Queen Victoria Street, London, E.C.4.

TECHNICAL BOOKS. Second-hand and New Books on every conceivable subject. Catalogue free. State wants. Books sent on approval. Books bought.—FOYLE, 121/125, Charing Cross Road, London.